

A photograph of an offshore oil rig against a clear blue sky. A large, thick plume of grey dust or sand is being discharged from the rig, drifting towards the left. The rig's structure is white with an orange deck. A large white dome is visible on the upper level. The image is partially obscured by a dark blue gradient overlay at the bottom.

# Reducing the ecosystem-based carbon footprint of coastal engineering

Technical publication



**Wetlands**  
INTERNATIONAL

Reducing the ecosystem-based carbon footprint of coastal engineering. Technical publication. June 2022.

### Authors

Rob Nieuwkamer<sup>1</sup>, Martine Kox<sup>2</sup>, Jasper Fiselier<sup>4</sup>, Daan Rijk Gerritse van Wieringen<sup>1</sup>, Femke Tonnejck<sup>3</sup>, Katherine Cronin<sup>2</sup>, Wisse ten Bosch<sup>1</sup>.

1. Witteveen+Bos
2. Deltares
3. Wetlands International
4. Independent consultant

### Acknowledgments

The authors thank Wouter van der Star (Deltares), Cinthia Soto (Wetlands International) and Tatiana Minayeva (Associated Expert Wetlands International) for their comments, feedback, and review throughout the preparation of this report. The views and opinions expressed are exclusively those of the authors and shall not be construed as views or opinions of the reviewers or their organizations. We are grateful for the funding provided by International Climate Initiative that made this publication possible.

*Suggested citation: Nieuwkamer, R., Kox, M.A.R., Fiselier, J., van Wieringen, D.R.G., Tonnejck, F.H., Cronin, K., ten Bosch, W. 2022. Reducing the ecosystem-based carbon footprint of coastal engineering (Wetlands International).*





*In collaboration with:*



# Deltares

*Supported by:*



# Table of contents

<b>EXECUTIVE SUMMARY</b>	<b>7</b>
<b>1 INTRODUCTION</b>	<b>12</b>
1.1 Background	12
1.2 Aim and scope	12
1.3 Reader's guide	13
<b>2 THE CARBON CYCLE IN COASTAL LANDSCAPES</b>	<b>16</b>
2.1 The carbon seascape concept	16
2.2 The carbon cycle	28
2.3 Reducing complexity	44
2.4 Conclusions	51
<b>3 IMPACT OF COASTAL ENGINEERING PROJECTS ON THE CARBON SEASCAPE</b>	<b>52</b>
3.1 Introduction	52
3.2 Types of coastal engineering projects	52
3.3 Dredging	55
3.4 Hydraulic structures	66
3.5 Conclusions	68
<b>4 ESTIMATING THE ECOSYSTEM-BASED CARBON FOOTPRINT OF COASTAL ENGINEERING</b>	<b>70</b>
4.1 Introduction	70
4.2 General assessment scheme	70
<b>5 LEGISLATION AND POLICY FRAMEWORKS</b>	<b>78</b>
5.1 Introduction	78
5.2 Current legislative and regulatory frameworks	78
5.3 Current policy frameworks	80
5.4 Financial incentives	82
5.5 Education and awareness raising	84
5.6 Knowledge development and innovation	84
5.7 Conclusions	85
<b>APPENDICES</b>	<b>86</b>
I Glossary	87
II Recommended further reading	89
III References	92



Source: Adobe Stock©



Source: Adobe Stock©

# Executive Summary

## The Problem

The ecosystem-based carbon footprint of coastal engineering projects, such as land reclamation, port development and coastal protection, is more significant and complex than previously thought. This is because such projects impact the carbon balance of ecosystems and sediments both on or off-site. Under some circumstances, the disturbance causes previously sequestered carbon to be emitted as greenhouse gases (GHG), while under different circumstances the exact opposite may occur. Although the emissions arising from the burning of fossil fuels can be very thoroughly quantified, emissions from ecosystem and sediment disturbance have not, until now, been sufficiently accounted for.

Coastal ecosystems such as mangroves, sea grass meadows, salt marshes and unvegetated intertidal wetlands contain sediments that are often rich in organic carbon. This is why they are referred to as 'blue carbon' ecosystems. Mangroves typically hold five times as much carbon as a similar area of rainforest. Due to their high carbon storage capacity, activities that interfere with the carbon cycle in these coastal ecosystems may result in significant GHG emissions. However, with the right adjustments, those emissions can be mitigated and even reduced. Moreover, there are also opportunities to enhance blue carbon sequestration by applying the so-called Building with Nature approach that integrates Nature Based Solutions into water and marine engineering practice.

Most coastal engineering affects coastal ecosystems and their carbon sequestration capacity directly, by dredging and displacement of sediment, but it can also do so indirectly, by changing the hydrological or sedimentation dynamics. For instance, ports and harbours are situated at the mouth of rivers, on sandy shorelines or adjacent to intertidal areas. Both carbon and nutrient cycling of coastal sediments are significantly impacted for example by the excavation of

a harbour basin and access channel, and construction of dams and quay walls. But also ports and land reclamations result in lower to no carbon sequestration, when coastal wetlands are transformed into urban areas and industrial zones. Smart, carbon-benign design of coastal engineering projects may provide a solution to mitigate those impacts.

## The urgency

To limit the temperature increase to 1.5°C above pre-industrial levels, as set out in the Paris Agreement, many governments have adopted targets to reduce their emissions by 50% by 2030 and by 95% by 2050. All stakeholders, including the hydraulic engineering sector, need to act urgently to bring down GHG emissions and enhance sequestration of GHG from the atmosphere. In the Netherlands, companies in the maritime and dredging sector that operate worldwide, have already adopted net zero targets by 2030 for fuel-based emissions.

Current efforts to reduce GHG emissions from coastal engineering focus mostly on the emissions related to the deployment of construction vessels and the supply of materials such as concrete and steel. However, the impact of these projects on the carbon balance of nearby coastal wetlands may be far greater. The effects on these coastal ecosystems are long-lived, and so may be ecosystem-related GHG emission or sequestration. To properly account for this, we need a pragmatic approach that also helps to determine management options.

## Aim of this report

This report presents a methodology for quantifying the ecosystem-based carbon footprint of hydraulic engineering projects along with potential options for reducing their carbon footprint, with a focus on coastal blue carbon ecosystems and coastal engineering. We hope to raise awareness, encourage discussion and action among the stakeholders who commission, finance, design, implement or maintain these projects.

## Ecosystem-based carbon footprint methodology

Over the last century, understanding of the carbon cycle has vastly grown, and analysis of carbon cycling in ecosystems has become increasingly complex. Previously, the quantification of biomass and soil organic matter degradation had been sufficient, but now an entire network of processes has to be analysed. Complex interactions and lateral flows between ecosystems are often involved, which is particularly relevant for coastal ecosystems.

In order to help coastal engineers and designers with practical guidance how to optimise the ecosystem-based carbon footprint of their projects, this complexity has to be reduced to its essence. Therefore, we highlight four types of perspectives:

Simplifying carbon cycling in the carbon seascape (chapter 2):

- 1. Ecosystem-based:** the processes that determine production, burial, decay and sequestration of organic matter in open coastal systems;
- 2. Long-term sequestration:** the emphasis on long-term storage of carbon in stable positions, most relevant at the time scales important for climate action;
- 3. Sediment-centred:** the characteristics of sediments and processes that determine sedimentation rates and release of carbon and nutrients from sediments.

Using these three perspectives we were able to simplify the complexity of organic carbon cycling in coastal systems and distilled the most relevant information that needs to be assessed in the form of a 'sediment passport'. The required information can be retrieved as part of standard field campaigns that are needed to underpin the design and execution of any engineering project.

And based on that, zooming in on the impacts of coastal engineering on the carbon seascape (chapter 3):

- 4. Project-oriented:** the activities within coastal engineering projects that influence organic carbon cycling, as well as potential adjustments in e.g. sediment handling that reduce emissions and increase sequestration.

The ecosystem-based carbon footprint of a project is then the difference between emissions from an undisturbed coastal zone (business-as-usual scenario) and the emissions arising from the coastal engineering project. Evaluation comprises four steps (chapter 4), which may run parallel to an ongoing Environmental Impact Assessment study:

1. A description of the carbon seascape where the project takes place;
2. A description of the coastal engineering project (the project alternative) and the business-as-usual scenario in terms that are relevant for the ecosystem-based carbon footprint;
3. Assessment of potential and relevant effects;
4. Calculating the ecosystem-based carbon footprint.



Figure 0.1: Our approach using four points of focus



## Adjustments that reduce GHG emissions from, and enhance carbon sequestration by, coastal engineering projects

Once the ecosystem-based carbon footprint of a project is calculated, it becomes possible to identify options to reduce it, by optimizing the design, use of sediments, modes of construction and maintenance. These include, among others:

- More carbon-benign handling of sediments during dredging, for example by optimizing dredging plumes, using the sequestration potential of sand pits, by adopting different approaches to the dredging of waterways and harbours, and for land reclamation.
- Beneficial use of dredging sludge; for instance for wetland creation and restoration, or land reclamation.
- Creating beneficial hydrological conditions, such as environments sheltered from waves, where higher sedimentation rates lead to coastal wetland development and its associated carbon sequestration.
- Careful release of dredged materials into the seascape, according to sediment characteristics (rich or poor in organic matter, fine sediments, or rich in carbonate), for example when used for beach nourishment, land reclamation, or coastal wetland development.
- Steering currents and reducing undesired sedimentation in navigation channels, and the compensation and mitigation of environmental effects.
- Adopting the Building with Nature approach and integrate nature in the design, implementation and maintenance of the coastal engineering project.
- Protection, restoration and creation of coastal wetlands, such as mangroves and salt marshes, because of their potential to store carbon. These can sequester 'blue carbon' in vast quantities, exceeding emissions from coastal infrastructure development.

## Policy, legislation and funding mechanisms

Nature conservation legislation and policies mandating the restoration of carbon-rich coastal and wetland ecosystems provide opportunities for capturing blue carbon. The EU Habitats directive limits conventional hydraulic engineering projects on sites included in the Natura 2000 network. Biodiversity frameworks provide targets for nature restoration and a focus on ecosystems that store carbon. Environmental impact assessments facilitate the inclusion of effects on biodiversity, ecosystem services and climate change into decision making.

Globally, the Paris Agreement requires action to minimize GHG emissions and enhance carbon sinks, but most countries have not yet adopted blue carbon strategies. Moreover, GHG emissions from hydraulic engineering projects are rarely included in carbon accounting and carbon pricing.

Incorporating the full scope of GHG emissions into national carbon accounting - including those associated with coastal ecosystems and dredging activities - is essential for optimising carbon mitigation strategies, reducing cost, and implementing incentives such as carbon pricing, targets and standards and allocating subsidies for mitigation. The ecosystem-based carbon footprinting methodology outlined in this report enables accounting for the full scope of emissions and suggests approaches to dealing with uncertainties.

Nations and other actors in the water sector can support climate- and ecosystem-friendly hydraulic engineering by adopting GHG reduction targets for the sector and by setting standards as requirement for permits or licenses. To successfully minimise carbon emissions, national policies and legislation need to be translated into project goals and tasks at the appropriate stages for design and engineering firms, contractors and maintainers overseen by the project commissioner.

Since the business case for climate- and ecosystem-friendly hydraulic engineering, in the context of a free market, is not yet sufficiently strong, additional funding mechanisms and the pricing of externalities are crucial. The most cost-effective solution is carbon pricing, through either a carbon market or carbon

tax. Further financial incentives can be provided by subsidising projects that purposefully sequester blue carbon, through voluntary carbon markets, by direct payments for wetland restoration, or by creating funding streams for the co-benefits of wetland restoration.

## Conclusions and recommendations

- We demonstrate that the ecosystem-based carbon footprint of coastal engineering projects can be significant and needs to be accounted for.
- We present a pragmatic ecosystem-based carbon footprinting methodology to support actors that commission, design or implement these projects to identify options that reduce their ecosystem-based carbon footprint.
- We encourage stakeholders to use this methodology, share data and findings, in order to enable its continued improvement and global uptake.
- Furthermore, we identify existing legislation and policies that enable climate- and ecosystem-friendly hydraulic engineering, along with recommendations to further strengthen the policy environment and associated financial incentive mechanisms.

## Chapter 1

# Introduction

### 1.1 Background

The Paris Agreement requires that each country has to report their nationally determined contributions (NDCs) of greenhouse gas emissions (GHG). NDCs embody efforts to reduce national GHG emissions and adapt to the impacts of climate change. Reducing the carbon footprint of projects is also of increasing importance for the hydraulic engineering sector.

In recent years, efforts within the hydraulic engineering sector focussed on the reduction of emissions associated with equipment e.g. more energy efficient vessels, using cleaner fuels and optimising logistics during construction. However, greenhouse gas emissions over the entire lifetime of a hydraulic engineering project are also caused by the moved and relocated sediment and it is believed that the GHG emission by the sediment is even more significant than the CO<sub>2</sub> emission by the equipment. Therefore, determining which environmental management options emit less GHG while also promoting carbon storage (blue carbon), is of great importance.

Most coastal wetlands, such as mangroves, salt marshes and sea grass beds, store large amounts of organic carbon in their soils and also sequester large amounts of carbon. Negative impacts on these wetlands may lead to GHG emissions exceeding the direct emissions from dredging or hydraulic works. On the other hand, there are also opportunities to enhance blue carbon sequestration by applying the so-called Building with Nature approach that integrates Nature Based Solutions into water and marine engineering practice (Bouw and van Eekelen, 2020). For example by supporting these coastal wetlands, or handling sediments so that more carbon is sequestered than lost. Hydraulic engineering projects, either during construction, or during extraction of sediments, can cause emission of previously sequestered carbon. Further emissions can occur many years after placement of organic rich material. However, hydraulic engineering

projects can also contribute to the sequestration of GHG, for instance by creating wetlands which absorb CO<sub>2</sub> from the atmosphere (blue carbon). Thus, for determining the carbon footprint of a project, all emissions and sequestration, over the entire lifetime of the project, have to be taken into account. However, to date, such GHG inventories have not been undertaken in the design and implementation of hydraulic engineering projects.

In order to be able to quantify the contribution of hydraulic engineering projects and assess the impact of alternative techniques or designs, stakeholders need more detailed knowledge on the sources of emissions, as well as a methodology or framework to enable quantifications. However, estimating GHG emissions from hydraulic engineering projects is more complex than previously thought, and only a few studies have attempted it. The issue of GHG emission and sequestration by hydraulic engineering projects was addressed by Fiselier and Vreeman (2012) and later by Tonneijck et. al (2018). Here, we further develop the ability to quantify relevant contributions, in different hydraulic engineering projects, including those that employ a Building with Nature approach. Our focus is on coastal engineering, although the findings may also have a bearing on hydraulic engineering more in general.

### 1.2 Aim and scope

The present report is about carbon in coastal ecosystems, the potential impact of engineering projects on coastal carbon stores, and opportunities to improve their ecosystem-based carbon footprint. With the aim of raising awareness, we outline approaches to quantifying ecosystem-based carbon emissions from coastal engineering projects. This will facilitate discussions of practical solutions and required investment among stakeholders in the sector, who commission, finance, design or implement such projects.

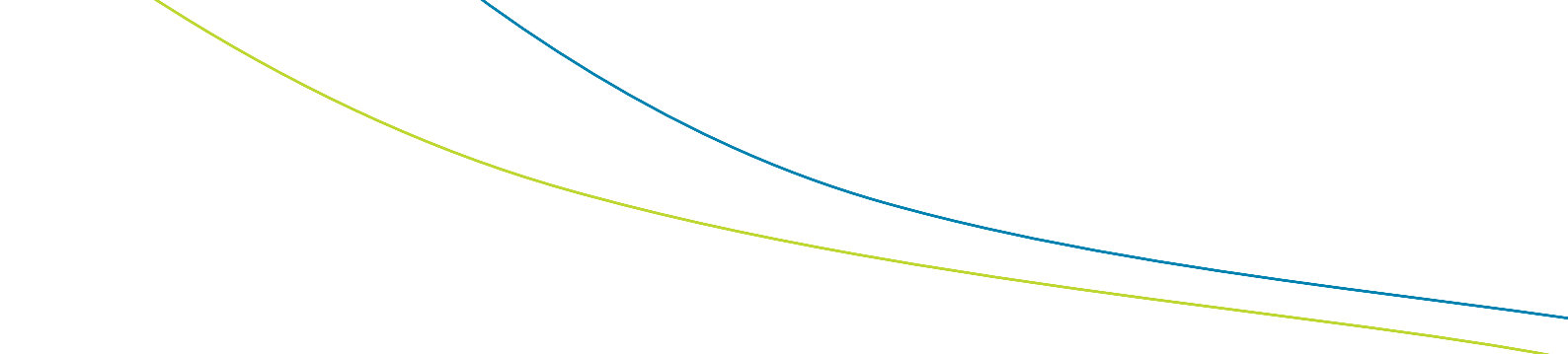

This report also describes how different interventions and environmental conditions determine the carbon emissions and sequestration potential of a coastal engineering project. Within the hydraulic engineering sector, the balance needs to be shifted towards reducing emissions and enhancing sequestration in order to meet climate goals. Possibilities to achieve this are investigated and recommendations are made for improving available policies and tools.

### ***For whom is this report intended?***

The principal target audience is the maritime hydraulic engineering sector. People in this field can be employed by national or local governments, financing institutions who commission the projects, or by engineering firms and contractors who design and build the structures.

We distinguish between engineers who work on coastal projects, and ecologists and sustainability professionals who work with coastal ecosystems and carbon management. Engineers will benefit from the account of the carbon cycle in coastal ecosystems. Sustainability professionals will benefit from the short introduction to hydraulic engineering interventions. Additionally, we describe how coastal engineering interventions influence carbon emissions and sequestration and how the ecosystem-based carbon footprint of projects can be calculated and minimized.

### ***After reading his report you know:***

- which hydraulic interventions in the coastal system carry a high carbon emission risk;
- what issues engineers need to address in their design process;
- what data to collect;
- which technical measures reduce emissions;
- existing policy measures and recommendations for the further improvement of policy tools.

## **1.3 Reader's guide**

The carbon cycle has been intensively studied all over the world for all sorts of ecosystems and habitats, from the level of microorganisms to dense tropical forests. Over the past century, understanding of the carbon cycle has improved. However, the analysis of carbon cycling in ecosystems has become increasingly complex. Previously, quantification of biomass and organic matter degradation in the soil was sufficient, but now, an entire network of processes, with complex interactions and lateral flows between ecosystems has to be analysed. In order to give hydraulic engineers and designers practical guidelines on the ecosystem-based carbon footprint of their projects, this complexity has to be reduced to its essence. Our approach uses the following line of reasoning (see Figure 1.1).

In **chapter 2**, we first describe the various forms of carbon in coastal systems, the processes and conditions that lead to its production, decay and sequestration, in vegetation, soils and sediment. It addresses the intricate relations between the organic and inorganic carbon in the carbon cycle and the intertwined network of carbon, nutrients and fine sediments. It discusses how carbon sequestration is strongly related to the type of sediment, conditions for sedimentation and the hydrological regime, such as drainage conditions, which influence the mineralization of organic carbon. It also stresses the interaction and lateral fluxes between rivers, ocean currents, coastal wetlands and sediments, illustrating the need for an ecosystem-based approach. We give an overview of major characteristics for different types of coastal wetlands and coastal sediments. It also describes the inherent complexity, the temporal and geographical variation in processes of short-term carbon sequestration. In order to reduce complexity, we introduce the concept of the coastal carbon seascape which is

Figure 1.1: The line of reasoning in this report

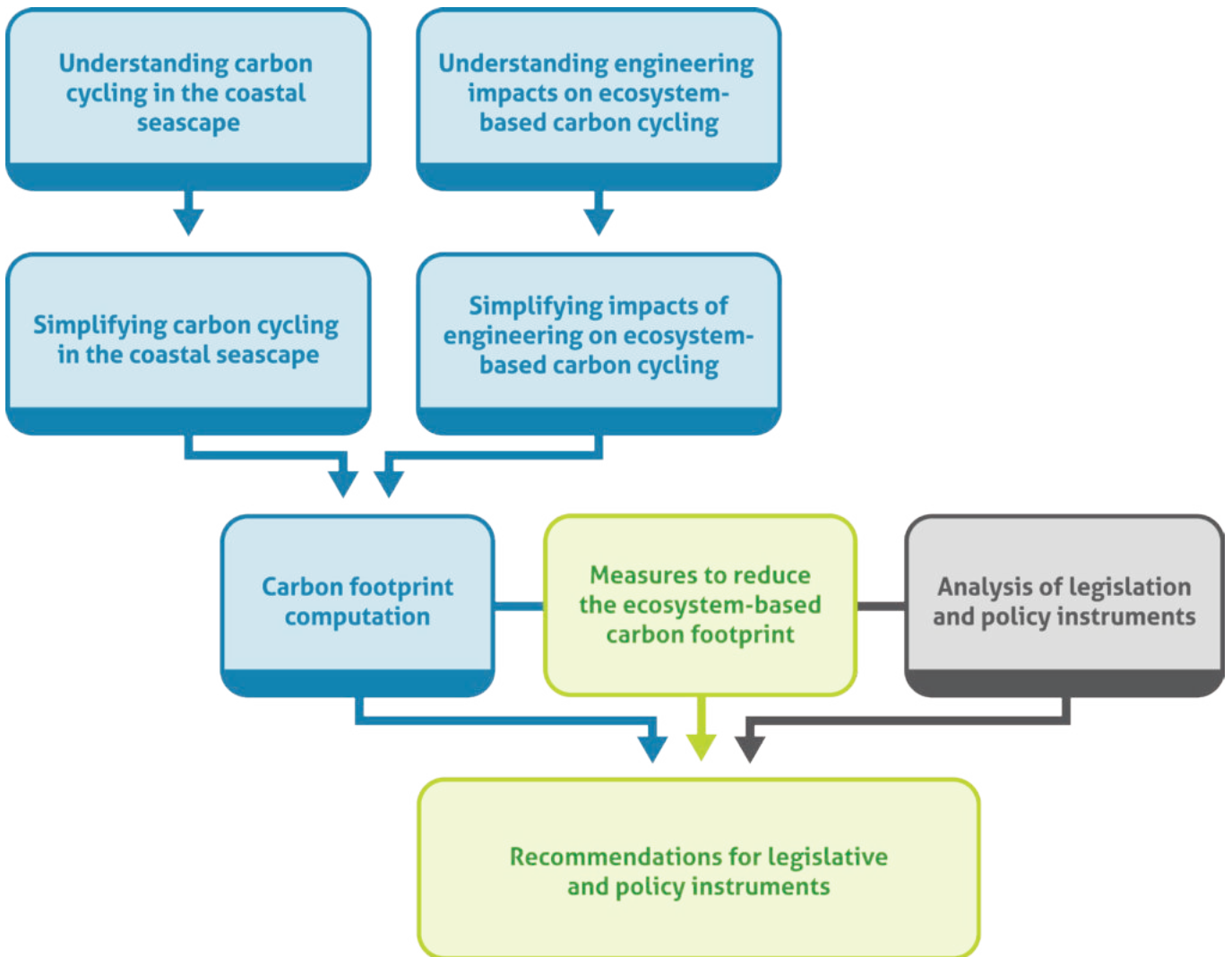

primarily based on different sediments and sedimentation conditions. It creates the context in which the impact of engineering projects can be visualized and understood.

**Chapter 3** describes how different types of coastal engineering projects may affect the carbon seascape. The focus is on sediment handling, changing hydrological conditions for sedimentation and effects on soils and sediments. Available options for design, construction and maintenance that reduce the carbon footprint of hydraulic engineering projects in coastal ecosystems are also given. We make recommendations for the integrated planning and design of sediment handling, hydraulic structures and coastal wetlands for coastal protection and land reclamation works.

**Chapter 4** describes how the ecosystem-based carbon footprint of a coastal engineering project can be calculated. It introduces an overall scheme and indicates what information should be available in the various steps, from conceptualization to project implementation. We discuss which parameters and data can have substantial effects on the carbon balance, using simple assessments and assumptions in accordance with the type of sediment. We propose a sediment passport that includes all necessary information and argue what proxies could be used for an initial assessment.

**Chapter 5** gives an overview of current legislative and regulatory frameworks. We discuss how reduction of GHG-emissions and carbon sequestration in coastal engineering projects can be stimulated using different policy tools, such as legislation, policy making, financial incentives, education and awareness raising, as well as knowledge and technology development and innovation. We distinguish three scale levels at which these policy tools can be applied: the international or global level, the national level and the project level.

## Chapter 2

# The carbon cycle in coastal landscapes

This chapter is about the carbon cycle in coastal ecosystems. In Section 2.1, we introduce the concept of the carbon seascape. The most important processes in carbon cycling are described in section 2.2. Section 2.3 suggests how we can reduce complexity. Based on these elements, we draw conclusions in section 2.4.

### 2.1 The carbon seascape concept

The marine landscape, or seascape, is like a terrestrial landscape (Pittman et al., 2018):

- both hold a variation of spatial structures which affects the functioning of that part of the landscape;
- both terrestrial landscapes and seascapes change over time;
- both encompass multiple scales, from local micro-organisms living between the sediment grains, up to mammals moving thousands of kilometres from one habitat to another.

The seascape concept assumes that the ocean is not one homogenous ecosystem, rather it is an interconnected mosaic of habitats, some thriving with life and others – barren.

The seascape concept emphasizes the spatial variability, open, dynamic and interconnected oceanographic features that are typical of marine environments (Kavanaugh et al., 2016; Pittman et al., 2018). It is this connectivity between marine ecosystems, exemplified by lateral flows of nutrients, that is vital for some habitats to form and organisms to thrive (Hilty et al., 2020). Likewise, carbon moves through the continuum of habitats and finds long term resting places in particular locations within the seascape.

Coastal landscapes have a role in all global biogeochemical cycles, but are particularly important for carbon. The coastal system acts as a buffer between land and ocean, starting from deltas, estuaries and salt marshes, through continental shelves, the open ocean and deep sea. Because of their position in the seascape, immense inputs of (terrestrial) organic carbon

and nutrients enter coastal environment via rivers, run-off and groundwater discharge. Yet, the coastal seascape only covers 7% of the global ocean surface (depth less than 200 m;  $29 \times 10^6$  km<sup>2</sup>), which can be subdivided into several habitats. All these habitats within each coastal zone experience different (a)biotic conditions, such as tidal influence, temperature and import of carbon and nutrients, influencing whether carbon is stored or not.

From a hydrodynamic point of view, we distinguish three zones within the coastal seascape: (1) the shallow coastal area with the intertidal zone, (2) the coastal offshore area with the continental shelf, less than 200 m deep and (3) the open ocean with the deep sea, deeper than 200 m (Figure 2.1).

From a sediment point of view, a distinction is made between deeper sediments, surficial soils and sediments and sediments subject to tidal pumping.

- Deeper sediments are not influenced by bioturbation and morphological processes, hence transformation of organic material is mainly by anaerobic processes. Neither are these deeper sediments subject to infiltration and outwelling, so the export of soluble components is very limited. Deeper sediments are often very old. In salt marshes and mangroves, sediments 1 metre down can be 500 to 1000 years old and in marine sediments even much older. In deeper sediments there is often a good correlation between the content of fines and clay, and the content of organic carbon. Due to their age organic carbon is mainly present in the form of recalcitrant organic matter;
- In surficial soils and sediments, oxygen plays a major role. The availability of oxygen depends on bioturbation by animals, roots, resuspension or flows of oxygen-rich water due to tidal currents or inundation, infiltration and drainage processes. In surficial sediments, the relationship between texture and organic carbon is variable. Despite the



Figure 2.1: Seascape with three distinguished zones: shallow coastal area with the intertidal zone, coastal offshore area (continental shelf) and open ocean. The figure also shows the estuaries which end up in coastal waters in the bottom left corner of the figure (After figure from Kuwae & Hori et al. 2019).

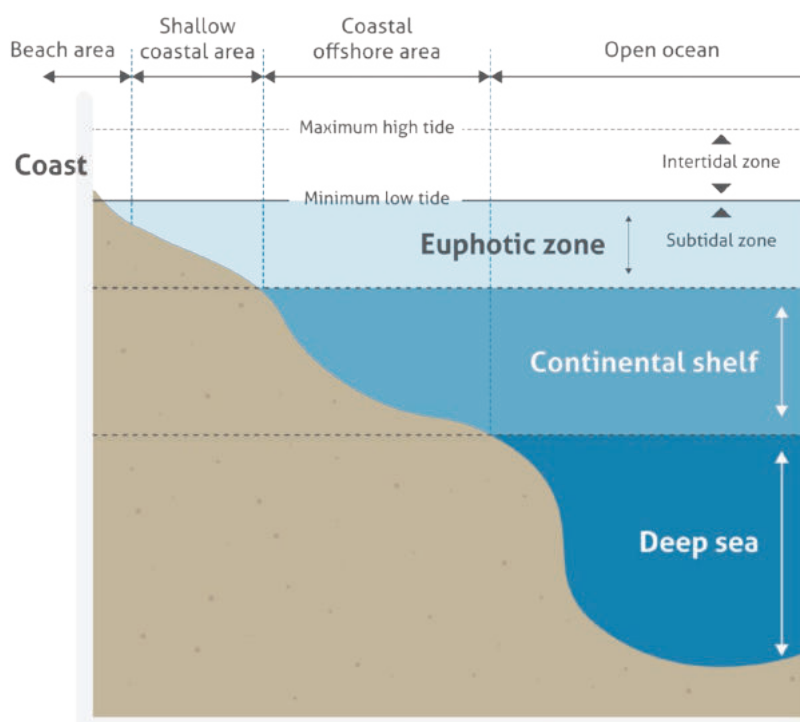
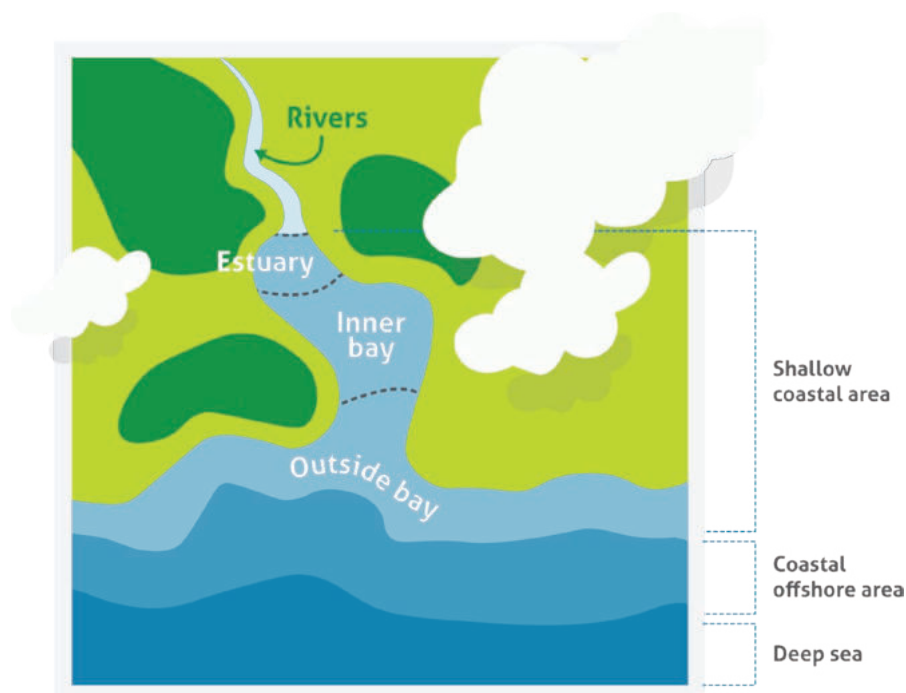

presence of oxygen, organic matter content can be high because of the large influx of plant debris, especially in coastal wetlands. The organic matter content is also high in waterlogged conditions, such as the backswamps of mangroves or on carbonate substrate. Surficial sediments in dynamic locations subject to waves and tides often have organic matter characteristics similar to those of suspended matter because of frequent sedimentation and resuspension. The percentage of recalcitrant organic matter is much lower than in deeper sediments;

- The sediments and soils that are located between low and high tide are subject to tidal pumping, the cycle of infiltration and outwelling. Inundated each day by the tides, these soils are subject to both sedimentation and infiltration of coastal water, enriching the soil with nutrients, minerals and organic matter. Salinity levels are constant even in arid climates. Infiltration during high tides is inevitably followed by draining during low tides, and the subsequent outwelling of porewater with Dissolved Inorganic Carbon (DIC), Dissolved Organic Carbon (DOC) and dissolved nutrients.

It should be noted that most processes are described for normal hydrological conditions, but that occasional storms or droughts can have significant impact on organic carbon and pore water concentrations. Major storms can move sediments to a depth of over 10 metres, leading to resuspension, intrusion of oxygen and transport as suspended matter or as density flows over larger distances. A major storm with a major inundation can flush out pore water and reset concentrations. A major storm can also cause the resuspension of sediments that have been stable for decades. Resuspension brings sediment in contact with oxygen-rich water, so the organic matter content of these sediments is often lower, with a high percentage of recalcitrant organic matter. Major storms may even change the coast line and lead to previously inundated areas to become regularly inundated and vice versa. Additionally, bottom trawling leads

to frequent resuspension and lowers organic matter content. In locations where the sedimentation rate is low and resuspension is high, the impact on organic carbon can be large as well, resulting in lower organic carbon content and a higher percentage of recalcitrant carbon.

Carbon is most efficiently stored in the vegetated parts of the intertidal zone, often referred to as 'blue carbon wetlands', which include mangroves, salt marshes and sea grass beds (Figure 2.3 and Figure 2.4). All of these coastal systems are potentially subject to hydraulic engineering activities, unlike the deep sea, which is therefore not included in this review.

Most of the organic carbon in coastal wetlands is stored in the soil and a large part of carbon sequestration depends on the capacity of coastal wetlands to filter and store sediment with associated organic carbon.

Looking at the seascape from a carbon storage perspective, vegetated intertidal coastal wetlands store more carbon compared to non-vegetated parts. Vegetated intertidal coastal wetlands are amongst the most efficient and intense carbon sinks on Earth. They make up only ~0.2% ( $0.9 \times 10^6$  km<sup>2</sup> (Nellemann et al., 2009; Tobias & Neubauer, 2009)) of the ocean surface, yet these vegetated coastal systems are responsible for 50-71% of the total burial of organic carbon in ocean sediment (Duarte et al., 2013; Nellemann et al., 2009). By far, the highest rates of organic carbon storage through burial are found in mangrove forests (1.39 ton C ha<sup>-1</sup> yr<sup>-1</sup>, range 0.20-6.54), sea grass beds (0.83 ton C ha<sup>-1</sup> yr<sup>-1</sup>, range 0.56-1.82) and salt marshes (1.51 ton C ha<sup>-1</sup> yr<sup>-1</sup>, range 0.18-17.3) (Alongi, 2020c; Nellemann et al., 2009). This high rate of carbon burial depends on multiple processes, but four key components are the carbon fixation rate, carbon available for burial, sedimentation rate and preservation of buried carbon (Macreadie et al., 2019).

Figure 2.2: Sediment environments and carbon sequestration seascape, cross-section.

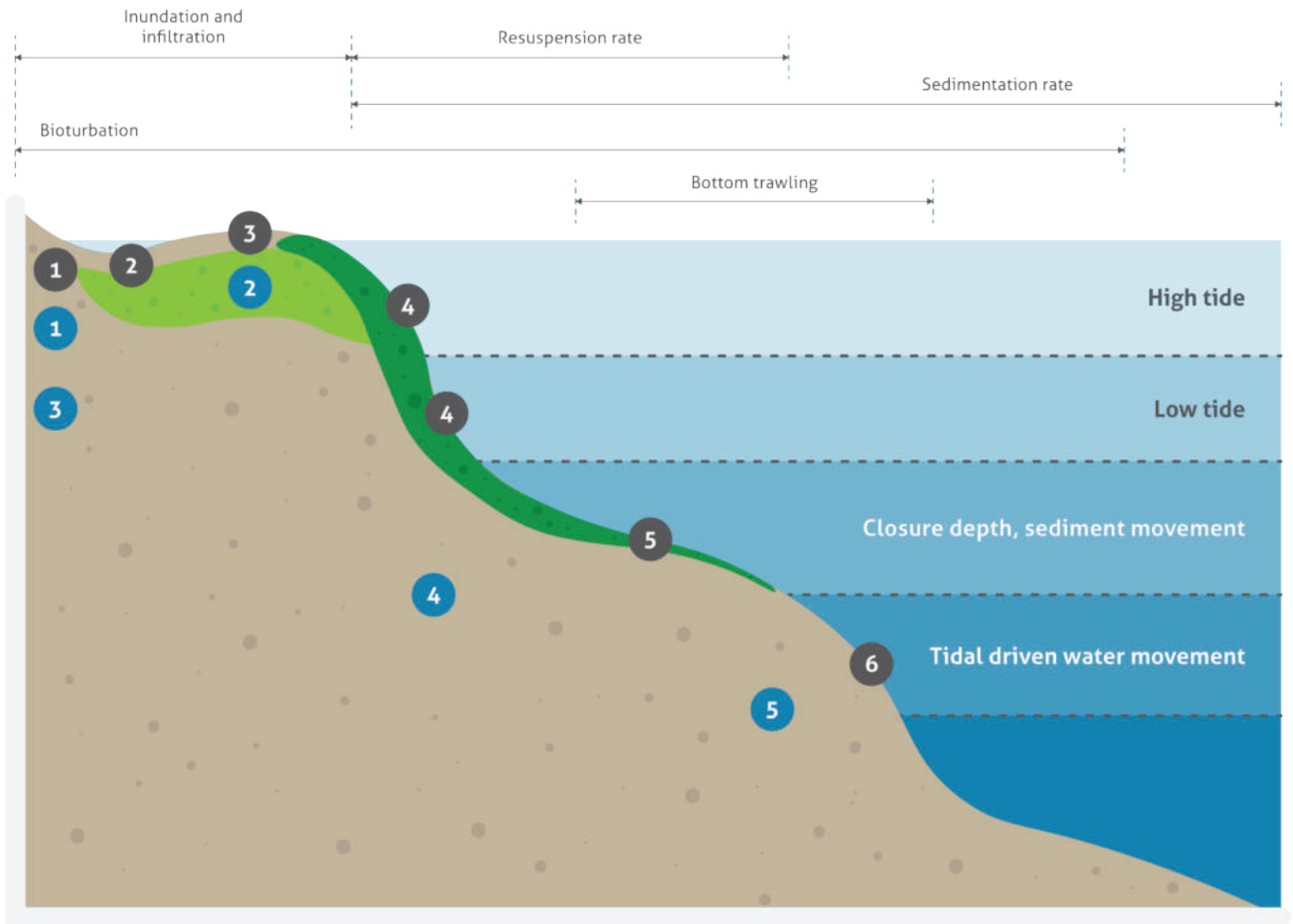

**Surface sediments and soils**

- 1 Constantly aerated and drained, but not inundated
- 2 Waterlogged, inundated, limited infiltration, tendency to peat formation
- 3 Frequently inundated, part of tidal pump, high input and output
- 4 Within reach of wave and tides, morphological and biological reworking of sediment, within phototrophic zone
- 5 Within reach occasional waves, morphological and biological reworking of sediment, within phototrophic zone
- 6 Some flow, oxygen rich, low SR, outside phototrophic zone, some bioturbation

**Deeper sediments**

- 1 Drained (constantly) aerated
- 2 Drainage during low tides, export of DIC, DOC, TA, dissolved nutrients
- 3 Anoxic, limited bioturbation.
- 4 Anoxic deeper older sediments, usually low in labile OM
- 5 Anoxic deeper, very old sediments, usually very low in labile OM

Figure 2.3: Examples of coastal ecosystems: mangroves, salt marsh, seagrass bed and mudflat (Source: top left: Pieter van Eijk, Wetlands International, top right: Wikipedia, bottom left: Wikipedia, bottom right: News 1 Korea).

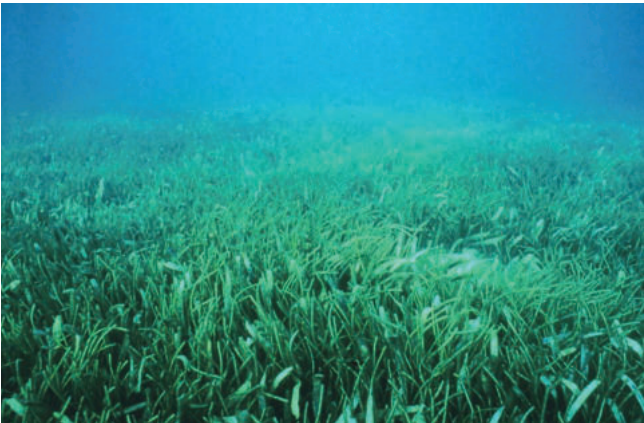

Figure 2.4: Blue carbon wetland distribution worldwide (Source: Pendleton et al. 2012).

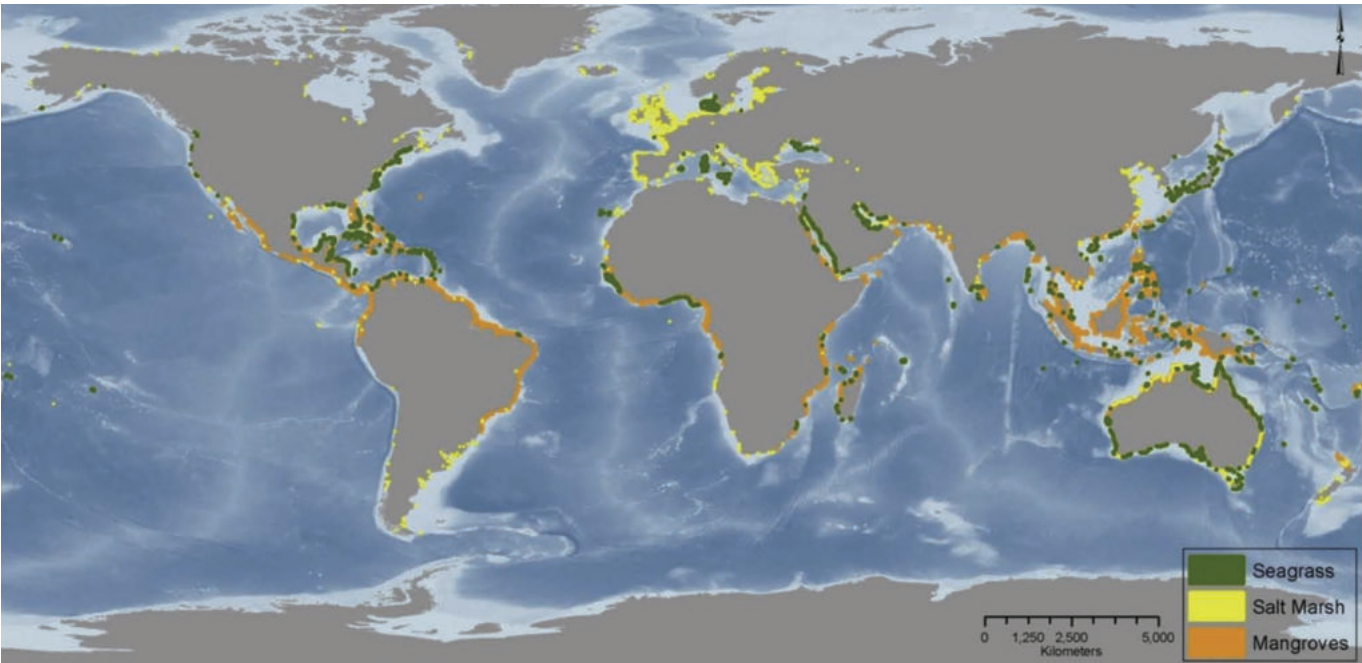

Table 2.1: Organic carbon burial rates and soil organic carbon stocks (Source: Nelleman et al. 2009).

Mean and maximum (in brackets) estimates of the area covered by blue carbon sinks and the annual organic carbon burial rates. Carbon burial rates are presented per hectare (mean, range and the upper confidence limit of the mean of individual ecosystem estimates, in brackets) and globally (as reported ranges of mean rates of global carbon burial derived using different methods and, in brackets, an upper estimate derived using the maximum area and the upper confidence limit of the mean burial rate). The data is for vegetated coastal areas and their percentage contribution to carbon burial in the coastal and global ocean (in brackets the burial rate and percentage contribution of vegetated habitats calculated from the upper estimates). Total burial rates of organic carbon in estuarine and shelf sediments and deep-sea sediments are provided for comparison.

Component	Area (Million km <sup>2</sup> )	Organic Carbon Burial	
		Ton C ha <sup>-1</sup> y <sup>-1</sup>	Tg C y <sup>-1</sup>
<b>Vegetated habitats</b>			
Mangroves	0.17 (0.3)	1.39, 0.20 - 6.54 (1.89)	17 - 23.6 (57)
Salt Marsh	0.4 (0.8)	1.51, 0.16 - 17.3 (2.37)	60.4 - 70 (190)
Seagrass	0.33 (0.6)	0.83, 0.56 - 1.82 (1.37)	27.4 - 44 (82)
<b>Total vegetated habitats</b>	<b>0.9 (1.7)</b>	<b>1.23, 0.18 - 17.3 (1.93)</b>	<b>114 - 131 (329)</b>
<b>Depositional areas</b>			
Estuaries	1.8	0.5	81.0
Shelf	26.6	0.2	45.2
<b>Total depositional areas</b>			<b>126.2</b>
<b>Total coastal burial</b>			<b>237.6 (454)</b>
% vegetated habitats			46.89 (0.72)
<b>Deep sea burial</b>	<b>330.0</b>	<b>0.00018</b>	<b>6.0</b>
<b>Total oceanic burial</b>			<b>243.62 (460)</b>
% vegetated habitats			45.73 (0.71)

Table 2.2: Different ecosystems Area, carbon stock (incl. biomass) and sequestration (Source: Alongi, 2020c).

Ecosystem	Area (10 <sup>6</sup> ha)	Mean C Stock (MgC <sub>org</sub> Ha <sup>-1</sup> )	Global Mean C Stock (Pg C <sub>org</sub> )	Mean C sequestration (g C <sub>org</sub> m <sup>-2</sup> a <sup>-1</sup> )	Global C Sequestration Tg C <sub>org</sub> a <sup>-1</sup> )	Current Conversion Rate (% a <sup>-1</sup> )	Carbon Emissions (Pg CO <sub>2</sub> -eq a <sup>-1</sup> )
Mangrove	8.34	738.9	6.17	179.6	14.98	0.16	0.088
Salt marsh	5.50	317.2	1.74	212.0	11.66	1.32	0.084
Seagrass	16.0	163.3	2.61	220.7	35.31	1.5	0.144
Coral reef	52.7	0.6	0.03	5.69	3.0	0.43	0.0005
Tropical coastal ocean	710.0	50.7	36.0	0.55	3.9	0.93	0.5
Tropical forest	1760	314.2	553.0	62.5	1100.0	0.53	10.8
Temperate forest	1040	280.8	292.1	28.9	300.0	0.70	7.5
Boreal forest	1370	288.3	395.0	18.0	246.6	0.80	11.6
Tropical grassland/savanna	2250	202.4	455.4	14.0	315.0	0.70	11.7
Temperate grassland	1250	181.1	226.4	16.8	210.0	0.55	4.6
Desert and xericshrub land	4550	26.3	118.7	9.5	432.3	0.3	1.3
Montane grassland/forests	519	173.9	90.3	ND	ND	0.49	1.6
Mediterranean forest	322	271.4	87.4	65.8	212.8	ND	ND
Tundra	835	1779.6	1486.0	63.2	528.0	ND	ND
Boreal peatlands	361	1182.8	427.0	53.1	191.7	ND	0.26
Tropical peatlands	58.7	2030.7	119.2	54.2	31.8	ND	1.48

### Mangrove forests

Mangrove forests are situated mostly in tropical and subtropical regions, in intertidal zones. They consist of mangrove trees that grow in saline to brackish waters. These ecosystems store the most carbon (6.17 Pg organic C in total system) (Alongi, 2020a) of any tropical terrestrial or marine ecosystem. Most of this is stored as organic carbon with  $738.9 \pm 28$  Mg organic C ha<sup>-1</sup>, of which 76.5% resides in soil ( $565.4 \pm 25.7$  Mg SOC ha<sup>-1</sup>) and the remaining 23.5% is in plant biomass (incl. roots) (Alongi, 2020b). The high amount of carbon storage is possible due to high soil carbon burial and slow turnover. The slow turnover is enabled by the conditions in which mangroves grow: extensive root systems, anoxic soils, waterlogged, no risk of fire, high sedimentation rates. Mangroves are efficient in carbon storage as they successfully take up large amounts of carbon, while only covering a fraction

(0.02-0.04%) of the sea floor ( $0.09 \times 10^6$  km<sup>2</sup> (Hamilton & Casey, 2016) to  $0.14 \times 10^6$  km<sup>2</sup> (Bunting et al., 2018)). Indonesia is the largest mangrove-holding nation by far with 26-29% of the global mangrove inventory (Hamilton & Casey, 2016).

Carbon burial rates in mangrove forests depend on many factors, including both abiotic factors (geomorphological setting, tidal impact, salinity, climate) and biotic factors (forest age, tree diversity, algae) (Mackenzie et al., 2021). Global mean estimates for carbon burial rates in mangroves have been reported at 239 g C m<sup>-2</sup> yr<sup>-1</sup>, with a high range of 5-1722 C m<sup>-2</sup> yr<sup>-1</sup> (Mackenzie et al., 2021).

The carbon stored in mangrove ecosystems is at risk of being remineralized and emitted as CO<sub>2</sub> or CH<sub>4</sub>. Land use change, and the subsequent deforestation

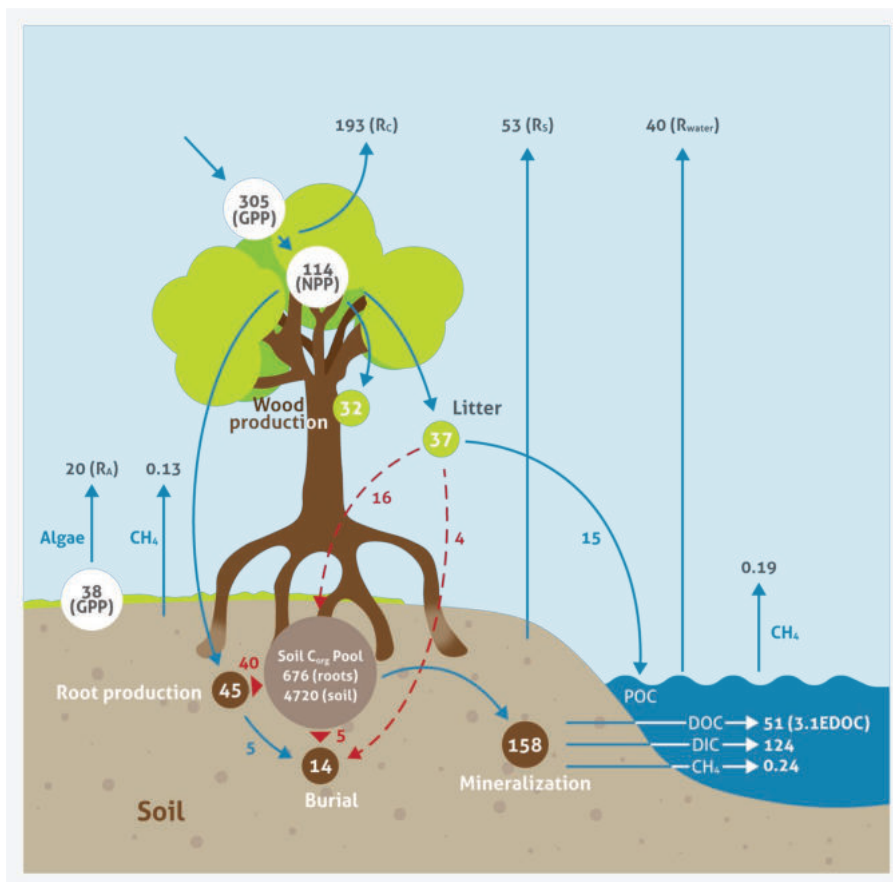

Figure 2.5: Mangrove carbon cycling (Source: Alongi 2020a).

A mass balance model of carbon flow through the world's mangrove ecosystems. Units are Tg C a<sup>-1</sup>. The budget assumes a global mangrove area of 86,495 km<sup>2</sup>. Solid blue arrows represent mean values based on empirical data. Dashed red arrows represent mean values estimated indirectly (by difference). The C<sub>org</sub> pool (both roots and soil) in soils to a depth of 1m is presented as a box in the forest floor with units of Tg C. Unquantified inputs of dissolved carbon from land-derived groundwater and organic matter inputs from adjacent marine and catchments are not depicted. Abbreviations: GPP = gross primary production; NPP = net primary production; Ra = algal respiration; Rc = canopy respiration; Rs = soil respiration at soil surface; RWATER = waterway respiration; POC = particulate organic matter; DIC = dissolved inorganic carbon; DOC = dissolved organic carbon; CH<sub>4</sub> = methane; EDOC = exchangeable dissolved organic carbon.

are the biggest threats. About 0.2% of mangroves are lost globally each year due to deforestation (Hamilton & Casey, 2016). Following deforestation, remineralization of stored carbon takes place and is emitted as CO<sub>2</sub> and CH<sub>4</sub>. This loss equals an area of 131-639 km<sup>2</sup> per year, equating gross potential loss as C of 2-8 Tg C yr<sup>-1</sup> (or 7-29 Tg CO<sub>2</sub> emission) (Atwood et al., 2017). The potential annual emission (as CO<sub>2</sub>e) due to mangrove deforestation is highest in Indonesia (3,511 Gg CO<sub>2</sub>e yr<sup>-1</sup>), Malaysia (1,288 Gg CO<sub>2</sub>e yr<sup>-1</sup>), United States (206 Gg CO<sub>2</sub>e yr<sup>-1</sup>) and Brazil (186 Gg CO<sub>2</sub>e yr<sup>-1</sup>) (Atwood et al., 2017).

Modelling carbon in mangrove ecosystems from a geomorphological perspective has pointed to a strong link between geomorphic setting and soil organic carbon content (SOC). The total soil organic carbon content of mangrove forests is highest in

those located in tidal systems (~1.2 Pg SOC), followed by small deltas (~0.7 Pg SOC) and lagoons (~0.25 Pg SOC). This is largely due to the fact that mangroves in these geomorphological settings are more common, even though they hold less SOC per unit volume. The less common mangrove forests growing on carbonate and arheic substrate (together ~7% of all mangrove forest), are estimated to store twice the amount of soil organic carbon per volume unit (resp. 53.9 ± 1.6 mg SOC cm<sup>-3</sup> and 60.1 ± 11.3 mg SOC cm<sup>-3</sup>), in contrast to SOC of mangrove forests in small deltas and tidal systems (both ~25 mg SOC cm<sup>-3</sup>). However, these results have not been validated by actual measurements in carbonate and arheic settings, showing much lower carbon content (Kauffman et al., 2020).

Figure 2.6: Global distribution of Mangroves depicted in red (Source: UNEP WCMC version 3.1, Spalding 2010).

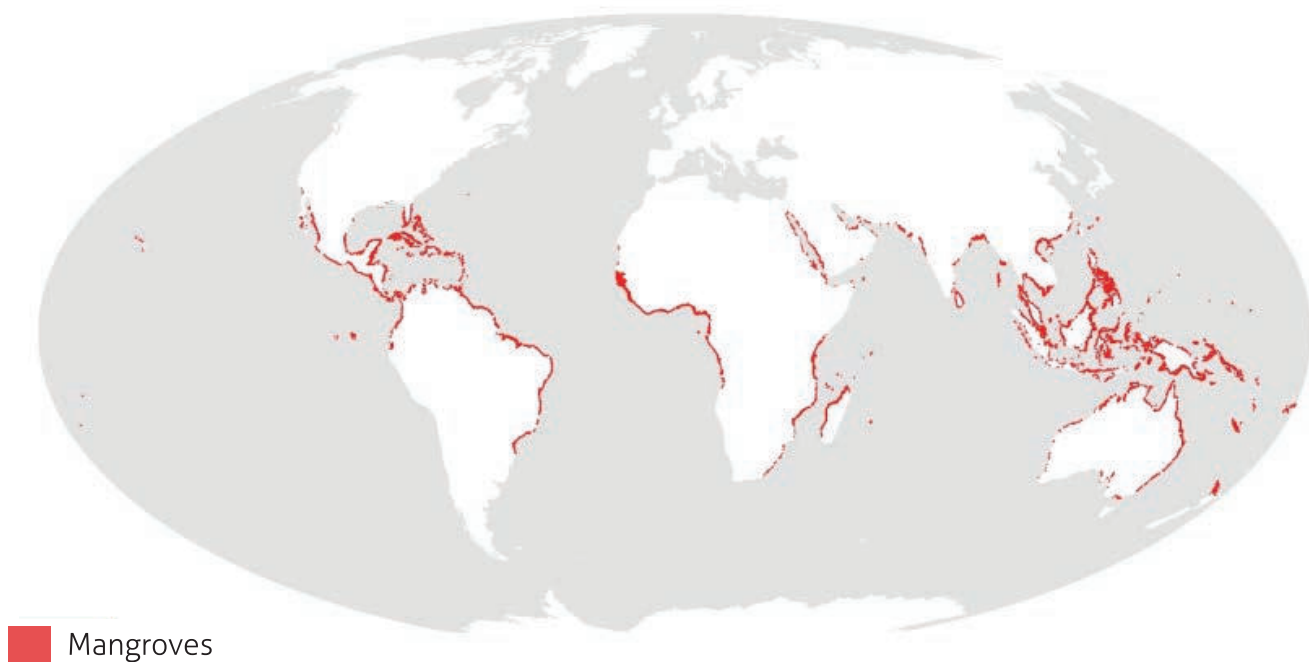



### **Salt marshes**

Salt marshes are the main type of coastal wetlands in the temperate zones at higher latitudes and they all occupy the intertidal zone. Salt marshes cover 0.055 million km<sup>2</sup>, of which most is located in North America (41%) followed by Australia (25%) (Davidson & Finlayson, 2019; Mcowen et al., 2017).

Salt marshes are vegetated, and thereby noticeably different from non-vegetated tidal flats. They store large amounts of carbon (1.84 Pg organic C, including plant biomass), of which 94% is stored in the soil ( $317.2 \pm 19.1$  Mg SOC ha<sup>-1</sup>; Alongi, 2020a). Although carbon burial rates are highly variable, depending on many factors, burial rates are higher in salt marshes ( $3.82 \pm 0.58$  Mg C ha<sup>-1</sup> yr<sup>-1</sup>) than in mangrove forests ( $1.62 \pm 0.67$ ) (Alongi, 2020a).

### **Sea grasses**

Seagrass meadows are important marine carbon sinks, yet they are threatened and declining worldwide (Samper-Villareal et al. 2016). Seagrass beds are typically found on soft substrates, with plenty of light, in temperate to tropical coastal zones. They may be on either intertidal and subtidal zones, but are typically found in shallow coastal waters (Short et al., 2018). Their coverage is estimated at 0.788 million km<sup>2</sup> (Davidson & Finlayson, 2019). The carbon stock in soils of seagrass meadows is estimated at 4.2-8.4 Pg C (Fourqurean et al., 2012), with carbon burial rates in sea grass ecosystems estimated to be 27.4 Tg C yr<sup>-1</sup> (Kennedy et al., 2010). The storage of organic carbon in seagrass meadow biomass (75.5-151 Tg C) is an order of magnitude lower than that of seagrass soils. The seagrass meadow soil develops over time in an organic-rich sediment layer, which remains largely anaerobic. Due to these conditions, organic carbon can be preserved for millenia (Fourqurean et al., 2012).

Figure 2.7: Global distribution of salt marshes in red (Source: UNEP-WCMC version 2.2, Mcowen et al. 2017).

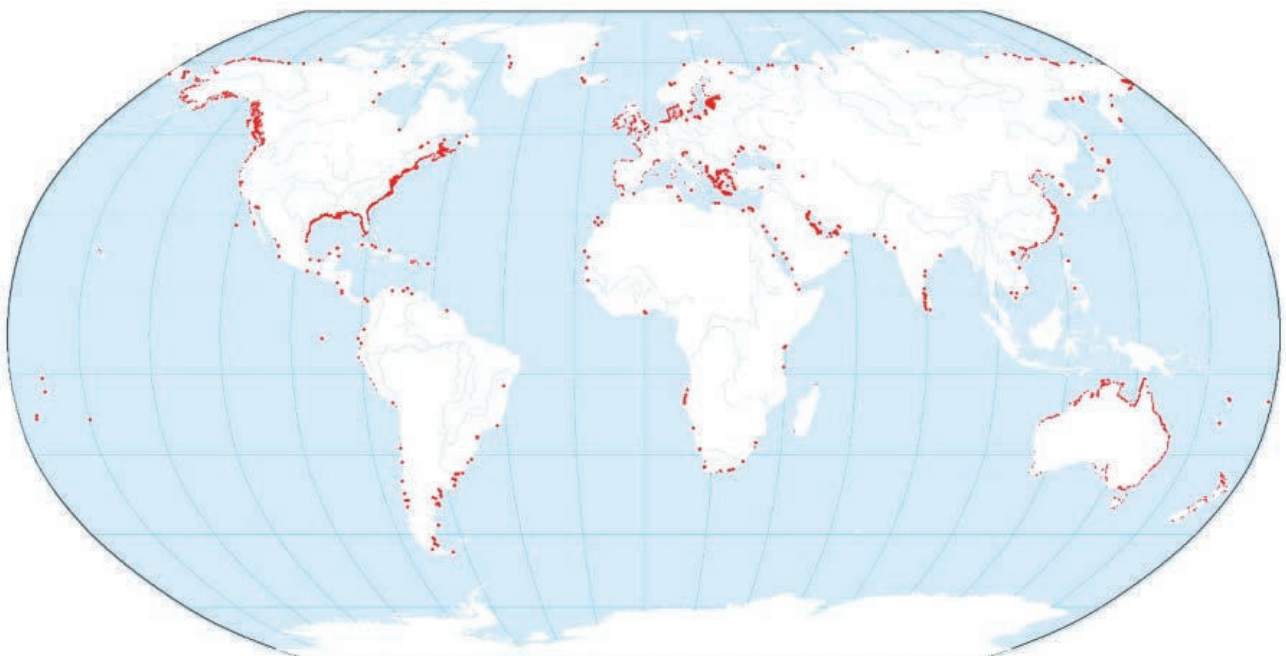
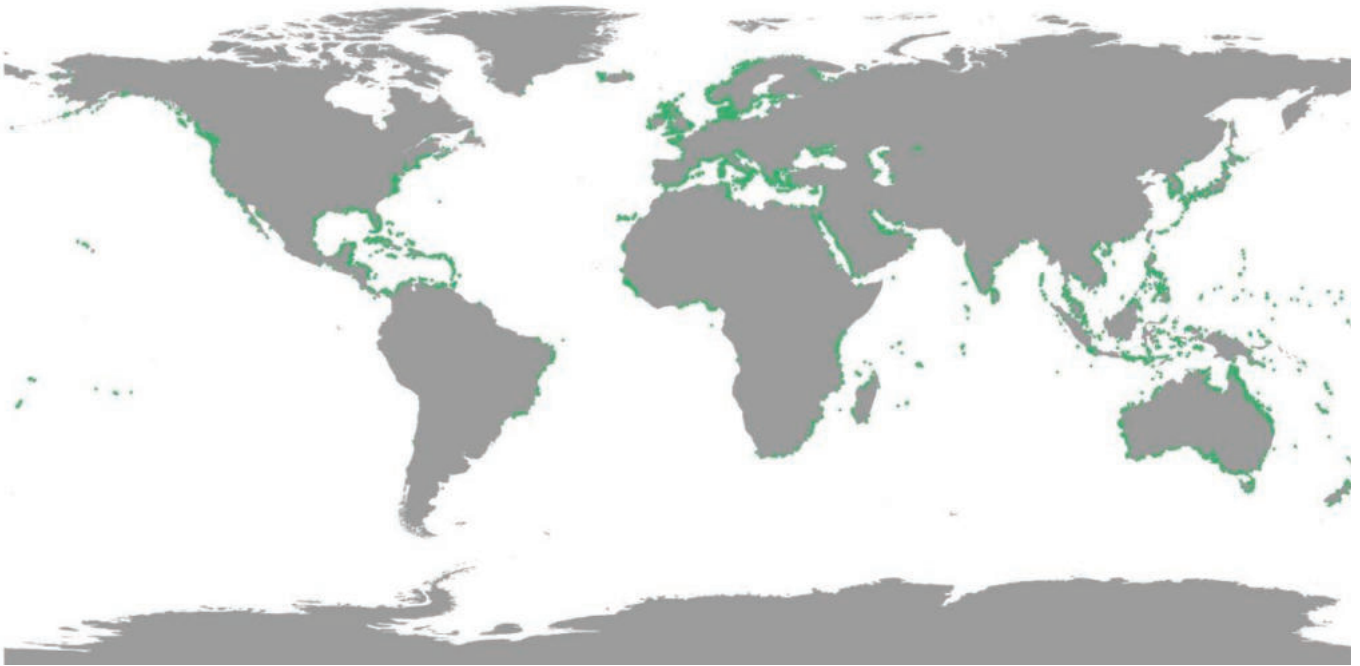

Figure 2.8: Global distribution of seagrasses in green (Source: UNEP-WCMC, Green & Short, 2003).



### ***Unvegetated intertidal wetlands***

Unvegetated intertidal wetlands include sandy, rocky and muddy sediments and beaches. They are far more abundant than vegetated systems (Table 2.3). Unvegetated tidal flats are estimated at 1.28 million km<sup>2</sup>, with the highest distribution in Asia (Davidson & Finlayson, 2019; Murray et al., 2019). Compared to the vegetated intertidal system (salt marshes, mangroves and sea grass beds), unvegetated tidal flats occupy 2.32 times greater surface area than vegetated intertidal wetlands. Despite their abundance, their carbon balance is poorly understood.

The critical factor for carbon fluxes in unvegetated tidal flats is sediment composition (W.-J. Lin et al., 2021; W. J. Lin et al., 2020). The finer and muddier the sediment, the higher the organic carbon content. In absence of vegetation on the tidal flat, benthic macro- and micro algae become the most important primary producers. Their productivity is also positively correlated with the amount of fine sediments in the tidal flats (W.-J. Lin et al., 2021; W. J. Lin et al., 2020). Algae

are, however, not the only source of organic carbon: the tidal inundation also imports large amounts of autochthonous organic carbon. Yet, the same tidal flows also export most of the carbon, as there are limited structures and processes able to hold the carbon in place.

Tidal flats have considerable quantities of carbon stored (78.07 Tg C), however that is less than vegetated coastal wetlands. Vegetated coastal seascapes can be inadvertently converted into unvegetated systems by sedimentation, alteration of hydrodynamics, over-exploitation and aquaculture.

Unlike vegetated coastal wetlands, tidal flats have not been reported to decline, however their quality is expected to deteriorate (Davidson & Finlayson, 2019). Furthermore, if the annual loss in cover of salt marshes, mangrove forests and seagrass beds results in an increase of non-vegetated tidal flats, the rate of carbon sequestration is also expected to decline by 13.10 Tg C/year (W. J. Lin et al., 2020).

Figure 2.9: Figure showing the global distribution of tidal flat ecosystems (Source: Murray et al. 2019).

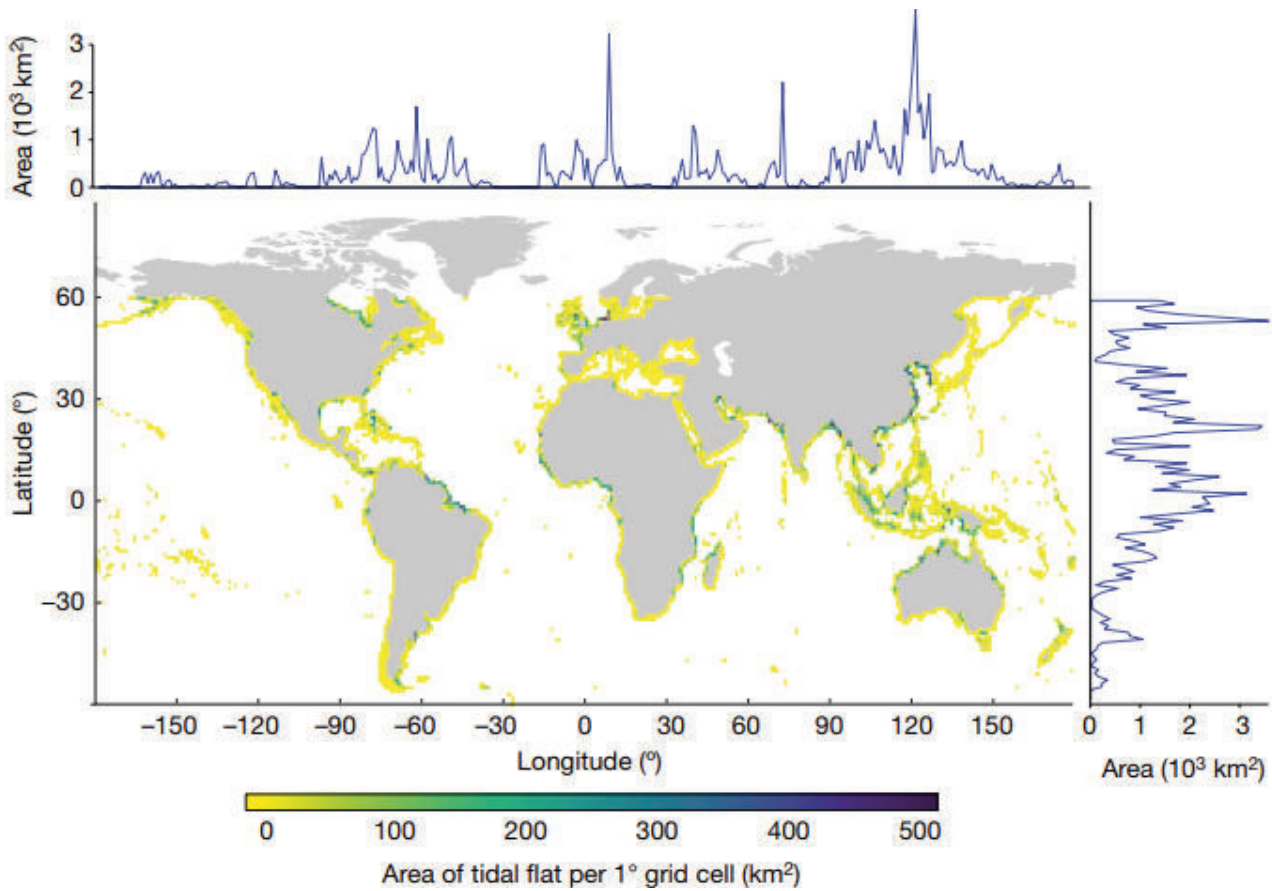

Table 2.3: Estimated tidal wetland surface area (vegetated (mangrove, salt marsh) and non-vegetated) per continent (Source: Tiner & Milton, 2018).

Continent	Salt/brackish marsh (hectares)	Unvegetated sediment (hectares)	Mangrove (hectares)
North America	2,575,000	16,906,000	510,000
Latin America	1,707,000	9,223,000	4,224,000
Europe	500,000	2,374,000	Not present
Asia	1,027,000	8,011,000	1,439,000
Africa	487,000	4,632,000	3,686,000
Australasia	461,000	4,641,000	2,253,000
<b>Total</b>	<b>6,758,000</b>	<b>45,788,000</b>	<b>12,112,000</b>



### **Continental shelf**

The continental shelf area is a much less significant carbon store. Nevertheless, it buries a total of 45.2 Tg C per year (Nellemann et al., 2009), while occupying a large fraction of the coastal ocean surface (26.6 x 10<sup>6</sup> km<sup>2</sup>). Therefore, carbon sequestration rates are low, at 0.2 ton C ha<sup>-1</sup> yr<sup>-1</sup>, and a burial rate of organic carbon that is much lower than that in vegetated coastal ecosystems (Nellemann et al., 2009).

## **2.2 The carbon cycle**

### **2.2.1 Schematic representation of the carbon seascape: carbon flux map**

The carbon cycle is a complex balance of processes that ultimately determine whether a system acts as a net carbon sink or source. The carbon flux diagram in Figure 2.10 combines inputs, conditions and processes with its associated final “resting” places. This includes blue carbon wetlands, coastal waters and sediments and oceans and marine sediments as major elements. In practice, these different compartments may need to be divided into sub-elements. Coastal wetlands are often found in interdependent combinations, such as sea grass beds, lagoonal sediments and mangroves that are protected by coral reefs, or mudflats and salt marshes, or mudflats and mangroves.

The essence of the carbon cycle is that organic carbon is continually produced and decomposed. Production of organic carbon (primary production) is a process only performed by plants and microorganisms, often using light as energy source. In aquatic ecosystems, inorganic carbon dioxide (CO<sub>2</sub>) is constantly exchanged between water and atmosphere. Once CO<sub>2</sub> is dissolved, it can quickly transform into bicarbonate or carbonate, depending on the acidity (pH) of the water column. This inorganic carbon can be sequestered in biomass (i.e. plant biomass) as organic carbon (glucose). Organic carbon can then be either stored deep in the sediment or returned to the atmosphere, as CO<sub>2</sub>, via decomposition. The process entails degradation of the organic carbon and respiration by decomposing organisms, resulting in CO<sub>2</sub> production. Decomposition is particularly fast when oxygen is freely available. However, once organic matter is buried

deeper in the sediment, it is prevented from further decomposition, as the lack of oxygen there limits microbial decomposition processes, and organic matter remains sequestered permanently.

Carbon in coastal wetlands and coastal sediments comes from various sources and takes different forms. We distinguish five sources of organic carbon:

1. Organic matter is brought in by rivers, mainly as dissolved organic matter (DOC) and as particulate organic matter (POC), originating from soil erosion in the river basin. Terrestrial forms of organic carbon (OC) begin as plant biomass, both natural and agricultural. Closer to river mouths, the proportion of terrestrial OC ending up in coastal wetlands and sediments is very high. This river input is highest in areas where, due to climate and nutrient rich soils, terrestrial primary production is high, such as along the coasts of the largely volcanic archipelago of Indonesia. In contrast, very limited influx is observed along arid and semi-arid coasts, such as in the Gulf of Arabia. Additionally, quantities of organic matter and nutrients can be very large when rivers originate in urban areas or areas with intense agriculture.
2. Another important producer of organic matter are marine algae. The largest source of marine organic carbon is in ocean upwelling zones, where nutrient rich water reaches the surface, for example near Peru. Rivers can also provide large amounts of nutrients: algal blooms can be observed in close proximity to river mouths, especially where these rivers flow through agricultural areas and larger urban areas.
3. A third source is the organic carbon formed by vegetated coastal wetlands, such as sea grass beds, salt marshes and mangrove forests. Their productivity depends again upon the availability of nutrients, which are mostly provided alongside fine sediments carried by the tides, or by long-shore currents. These vegetated coastal wetlands are able to filter and capture fine sediments, including POC, so the input of organic material and nutrients is often very high.

4. A fourth source are benthic algae that live on surficial coastal sediments, provided there is sufficient light available for photosynthesis, as well as in all types of coastal wetlands, where benthic algae are found on soils, stems and leaves.
5. A fifth source is wind-blown black carbon that originates from bush and forest fires. Black carbon is non-reactive and it can constitute a substantial part of the soil organic carbon found along the coast of Australia, in areas with low sedimentation rates, or in sediments and coastal wetlands near major sources, such as bush fires, or slash-and-burn agriculture.

Summarily, at a regional scale and over longer time periods, organic carbon is produced in uplands and coastal wetlands in high C/N and C/P ratios. The decay of organic matter starts with its transport towards the sea, leading to lower C/N and C/P ratios and a high ratio of labile to recalcitrant organic carbon. In the sea and in wetlands, this partly mineralized organic matter is further decomposed, but labile organic matter is newly created as a result of primary production, by marine algae, benthic algae and plants. Thus, organic matter near the coast is a mix of older and newer organic matter, of labile and recalcitrant forms of organic carbon that have been synthesized autonomously or brought in from land or ocean. Consequently, the organic carbon found in soils and sediments is often a mixture from different sources, varied with the geographical position of coastal wetlands and sediments. Mangrove litter may contribute to organic carbon in sea grass beds and vice versa, and coastal algal blooms may enrich mangrove sediments. Except for benthic algae, all other individual sources contribute between 25 and 50% of the organic carbon found in coastal wetlands.

Figure 2.10: Carbon flux map with schematic representation of carbon fluxes in and between blue carbon wetlands, coastal waters and oceans

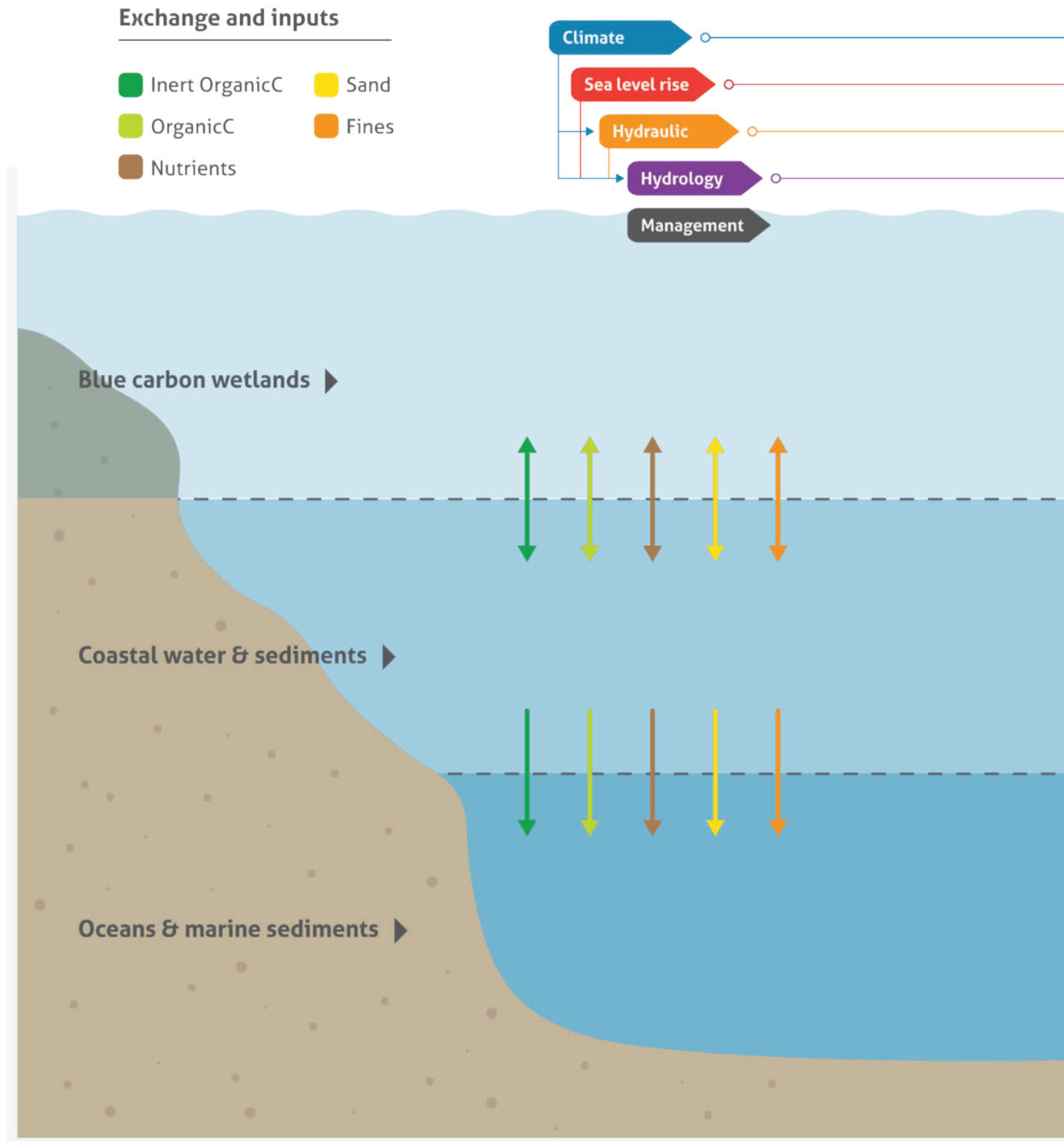

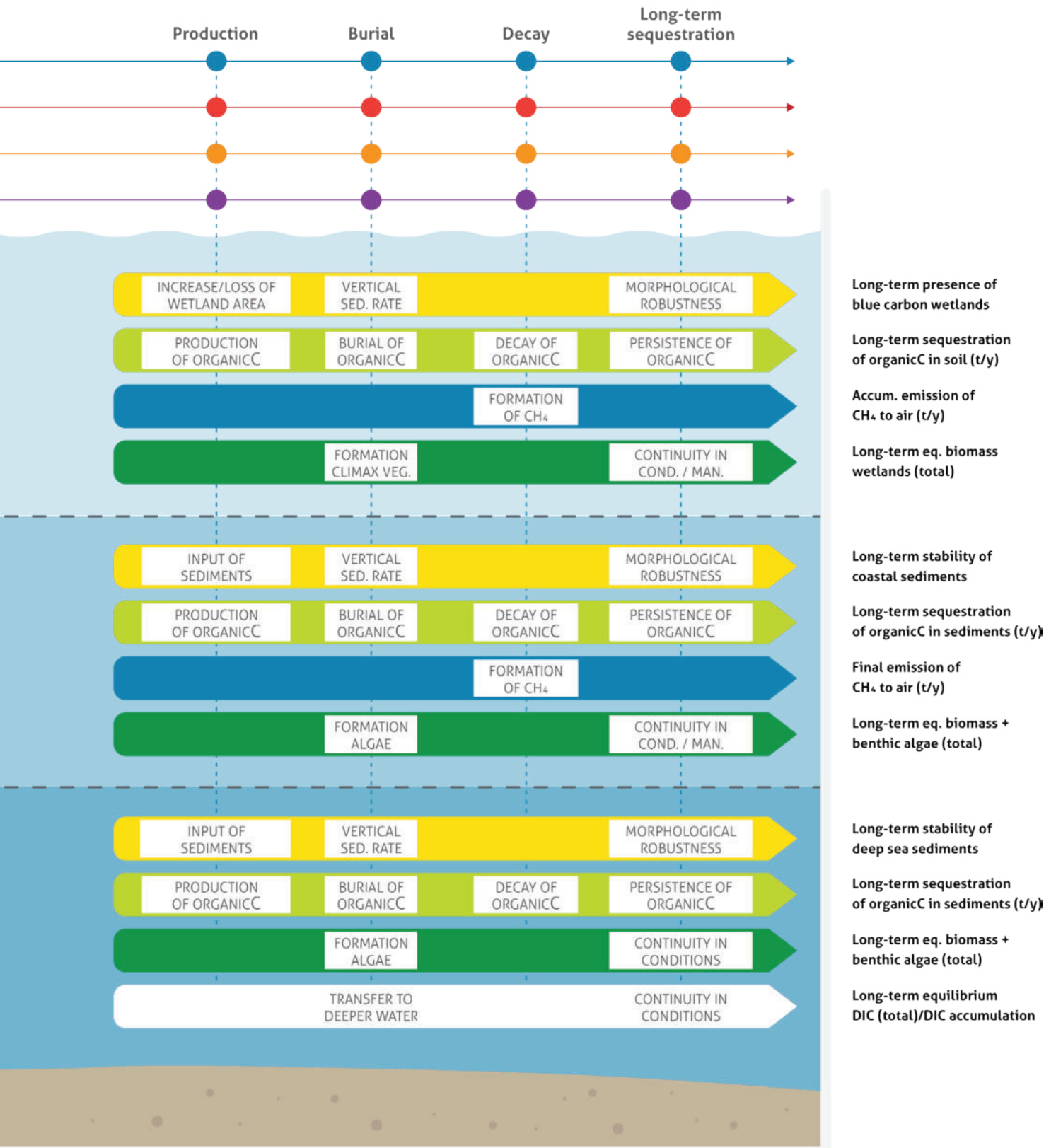

### 2.2.2 Production of organic carbon (primary production)

Nutrients are essential to the formation of organic carbon, and the ratio of C/N and C/P differs between terrestrial plants and algae, and organic matter in its subsequent degradation stages. Generally, C/N and C/P ratios tend to be high in mangrove litter and stems, but lower in marine algae (Figure 2.11). Since nitrogen is preferentially consumed in the mineralization process, the C/N ratio also tends to be lower in older soils and in recalcitrant organic matter.

The C/N and C/P ratio need to be compared to known Redfield ratios. The Redfield ratio indicates how much C, N, P, Fe, and Si in the case of diatoms, is needed for primary production. When one of these elements is present in an amount smaller than needed, it may be limiting for primary production.

In open marine environments, pelagic and benthic algae are the most important primary producers. For these marine environments, the Redfield ratio indicates the stoichiometric requirement for carbon, nitrogen and phosphorus in organic matter.

The Redfield ratio is 114C:14N:1P. The Redfield ratio is an average, since there are differences between different regions, and algal communities adapt, to a certain extent, to the nutrients available. So when nitrogen and phosphorus are scarce, comparatively more carbon is bound in organic matter. In terrestrial plants, the ratio carbon to phosphorus and nitrogen is usually higher, which is also the case for mangroves, salt marsh vegetation and sea grass.

#### Relevant biologically available P and N

Not all forms of nitrogen and phosphorus are readily available for primary production. Most of their soluble forms are, but phosphorus in particular can be chemically bound to iron and calcium, depending on Eh/pH conditions. Also carbon and associated nutrients, can be bound in recalcitrant forms of organic matter, that do not mineralize. Consequently, when expressing the potential of C/N and C/P ratios, one should consider carbon, nitrogen and phosphorus in labile organic matter and in other biologically available forms. This is especially relevant when considering the impact of dredging or erosion on coastal primary production.

Figure 2.11: Degradation state of coastal sediments in the Osai Inner Sea Japan show how low the percentage of labile organic matter can be. Most of the refractory organic matter consists of humins (Source: Asaoka et al. 2020).

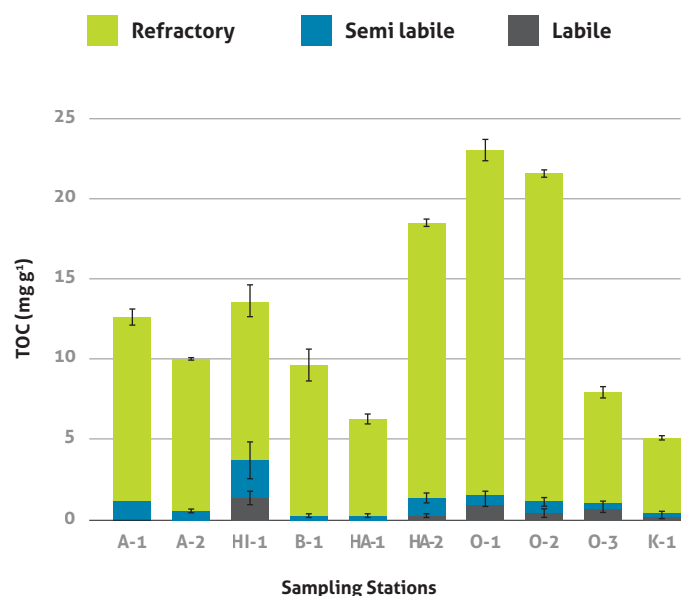
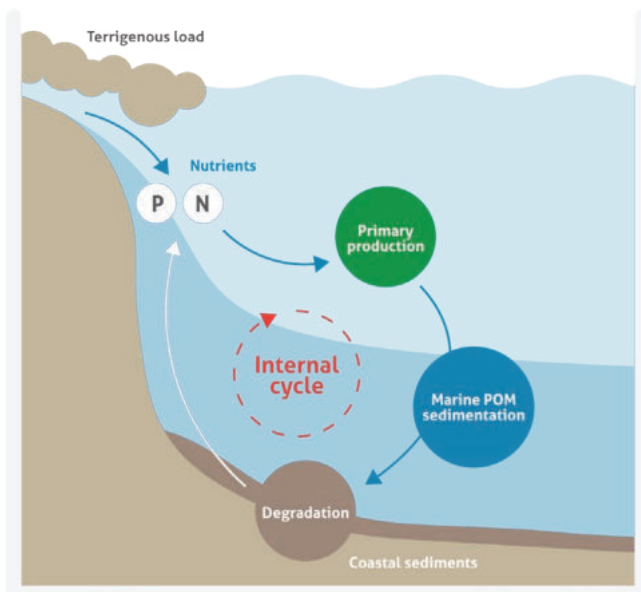
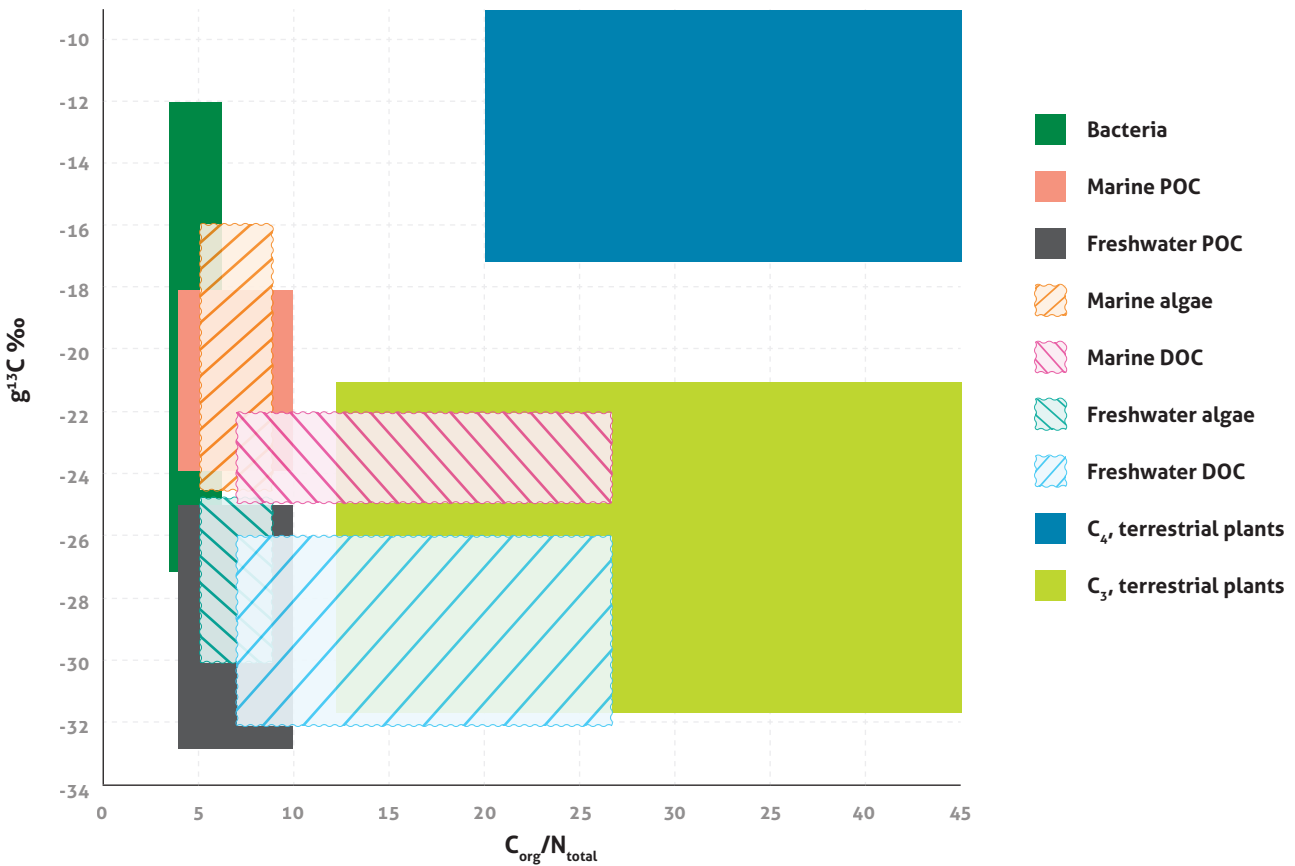



Figure 2.12: C/N ratios for different types of DOC and POC



When estimating the ecosystem-based carbon footprint of engineering works, one needs to consider the C/N and C/P ratios of their reactive forms. To simplify, exposing sediments with labile organic matter with a reactive C/N ratio above 6.7 and/or reactive C/P ratio above 114, risks excess carbon release and, hence, emission of CO<sub>2</sub>. In more detailed assessments, one may need to consider local Redfield ratios and indication of either P-limited or N-limited primary production.

### 2.2.3 Decomposition of organic carbon

Organic matter (OM) can be reworked several times before reaching the sea, being transformed from leaves, into biomass of leaf eating animals and ultimately decomposed by bacteria. OM that is easily decomposed is labile and is only found in recent deposits in surface sediments and in top soils. The most labile substances are decomposed within hours, a reason why only a small proportion of dead algae

reaches the marine sediments. Decomposition transforms labile organic carbon into recalcitrant organic matter, where a large proportion is released as CO<sub>2</sub> gas and dissolved CO<sub>2</sub>. The process of decomposition of organic carbon is much faster when oxygen is available, and continues in anaerobic conditions deeper in the sediment, albeit much slower.

Deeper in soils and sediments, organic material is typically much older and the proportion of non-reactive, or recalcitrant forms is higher. At sediment depth of one metre in salt marshes and mangroves, organic matter is likely to have been formed and buried 100 to 500 years ago. At the same depth in coastal sediments, the age can be several thousand years. More resistant forms of organic matter may also have been transported multiple times by occasional storms. Hence, organic matter found further from the coast and river mouths is often older, with a higher percentage of recalcitrant organic carbon.

In coastal wetlands, such as sea grass beds, salt marshes and mangrove, most of the organic carbon is sequestered in the soil, often as high as 80%, and the rest is present as biomass, as stems, leaves and roots. Organic carbon content is usually higher in the topsoil and lower in deeper soils, where contents are higher when soil texture is finer. The total stock of organic carbon depends mostly on soil depth, but usually for comparisons between coastal wetlands, only the top 1 metre is considered.

The result of these processes is that there is a great variation in the amount of organic matter in coastal sediments and wetlands in different locations. On a global level, climate, especially temperature and rainfall, nutrient and fine sediment availability determine primary production and sequestration, leading to large variation in organic carbon (Figure 2.13).

Furthermore on a regional and local scale, there is a large variation in soil organic carbon content (SOC) within coastal wetlands. This variation is due to differences in climate conditions, influx and production of organic matter, its burial, decay and decomposition. There are marked differences between the low and high zones of salt marshes, between fringe and interior mangroves, between sea grass beds under different environmental conditions that determine the availability of nutrients for primary production, of fine sediments that further sequestration and oxygen for decay. For example, the very high SOC content in mangrove soils in Indonesia may be explained by very high primary production, due to a long growing season and rich volcanic soils, which also leads to a large influx of terrestrial organic matter and very productive mangrove forests. Tephra, which is abundant in soils and sediment in this region is of volcanic origin and has a high iron content which helps to sequester organic carbon in less labile forms.

When organic matter is mineralized, labile organic matter is entirely decomposed, releasing nutrients and carbon, which will partly be transformed into more recalcitrant forms of organic matter. These usually have a higher carbon to phosphorus and nitrogen ratio. Phosphorus and nitrogen that are released, can be chemically bound to soil particles or find their way into the water column due to diffusion.

When a river enters the sea under natural unperturbed conditions, it usually carries POC and DOC with high carbon to nitrogen and phosphorus ratios. Upon mineralization, carbon is often outgassed to the atmosphere as  $\text{CO}_2$ , and the released nutrients contribute to primary production. However, if this primary production is mainly the work of algae, carbon is bound as per the Redfield ratio. As a consequence, there is an excess of  $\text{CO}_2$  that cannot be bound by renewed primary production and the delta or estuary acts as a source of  $\text{CO}_2$ .

The above is applicable to unperturbed, natural conditions. Where rivers are heavily polluted by agricultural drainage or untreated sewage, the C/N and C/P ratio of the river water becomes very low. If it falls below the C/N ratio for marine primary production, the river water will induce high rates of photosynthesis and the delta or estuary where the river enters, will act as a carbon sink. An example of the latter is the Yellow River, that, upon entrance in the sea, changes from a source to a sink for carbon, since pollution drastically reduces the C/N ratio.

#### 2.2.4 Carbon sequestration

It would be a fair assertion that, when carbon is buried in sediments with high C/N and C/P ratios, available nutrients have been efficiently used in the sequestration process. The question is, which parts of the coastal carbon seascape have the highest C/N and

C/P ratios and are the most efficient at sequestering carbon where phosphorus and/or nitrogen are limiting factors for primary production, and, ultimately, in the sequestration of organic carbon. Locations with high sedimentation rates that bury POC and DOC with high C/N and C/P ratio, such as river deltas, may be nutrient efficient locations for sequestration of carbon.

### **Mineral content of a soil**

Chemical binding plays a role in binding both carbon and phosphorus, as well as for the anaerobic decay of organic matter, a process largely controlled by sulphur and iron. This accentuates the importance of the mineral content of soils and sediments. Since sulphate is readily available in sea water, sulphur is the predominant electron acceptor for the decay of organic matter. This is most frequently the case where sulphur is continually replenished.

High content of iron and sulphur may indicate a high potential for long-term carbon sequestration. Since long term carbon sequestration mainly takes place in deeper soils, anaerobic processes determine long-term sequestration rates. Of further importance appears to be the presence of tephra, a volcanic de-

posit that is rich in iron and stimulates the binding of organic carbon in a way that contributes significantly to sequestration.

### **Cascade of organic matter and related nutrients**

Most organic matter and related nutrients cascade over years and sometimes centuries towards their final resting places, either in coastal wetlands, shelf sediments and deep sea sediments, or become part of plankton, plant and animal biomass. The ratios C/N, C/P and also C/fines differ in these varied environments. Where phosphorus, nitrogen and fine sediments are limited, the highest sequestration of carbon along this cascade is observed if most of the carbon is sequestered with comparatively little amounts of nutrients and fine sediments, i.e. high ratios of C/N, C/P and C/fines. Thus, when sediment is moved, either by dredging, erosion or sedimentation, it can move from an environment with a higher to lower organic carbon sequestration capacity. Where this is the case, the combination of dislodged carbon and nutrients may turn the sediment into to a source of CO<sub>2</sub>. Conversely, moving it to an area with a higher organic carbon sequestration capacity, may result in it becoming a sink for CO<sub>2</sub>.

Figure 2.13: Global overview of Soil organic Carbon per hectare stored in mangroves across the Earth (Source: Sanderman et al., 2018).

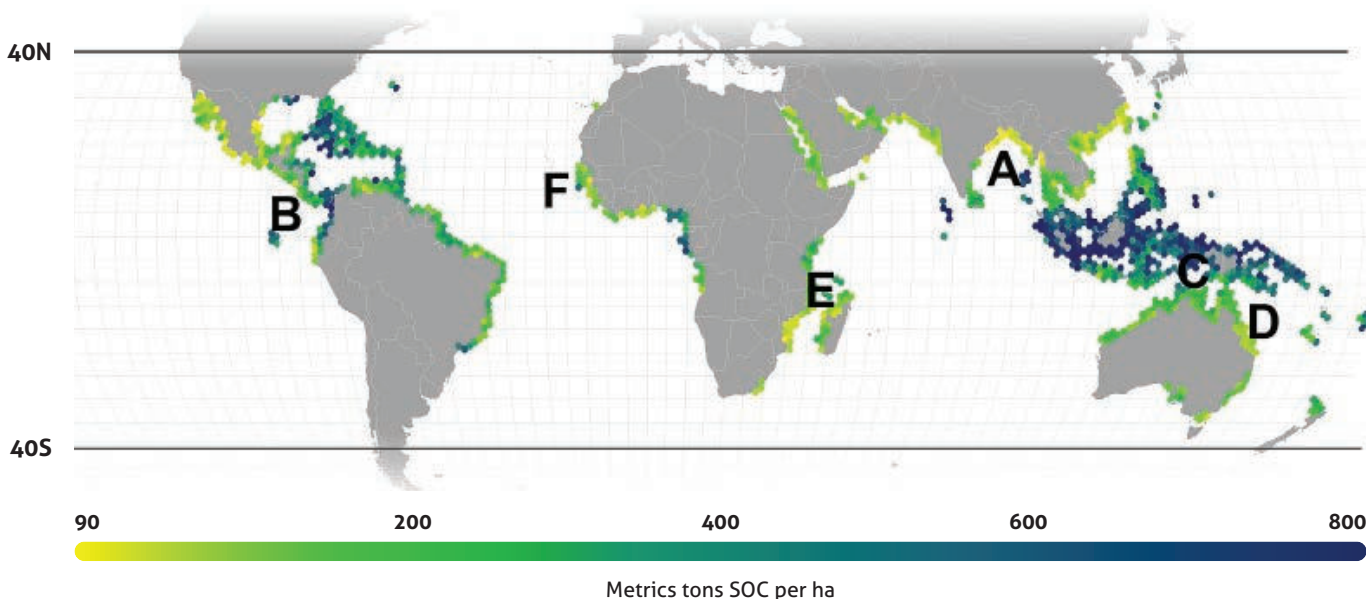
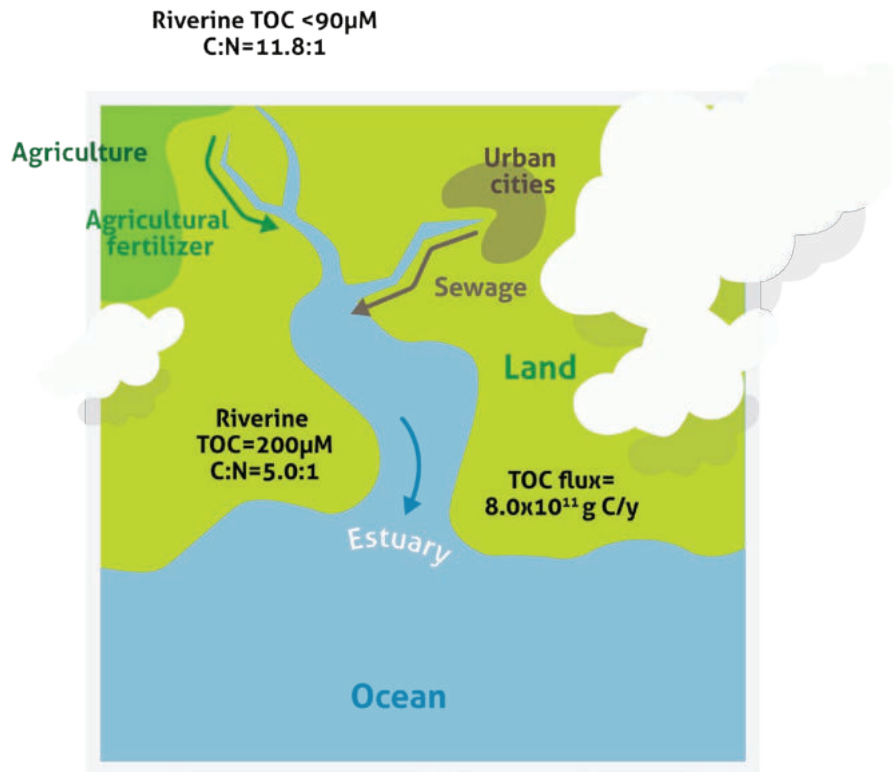
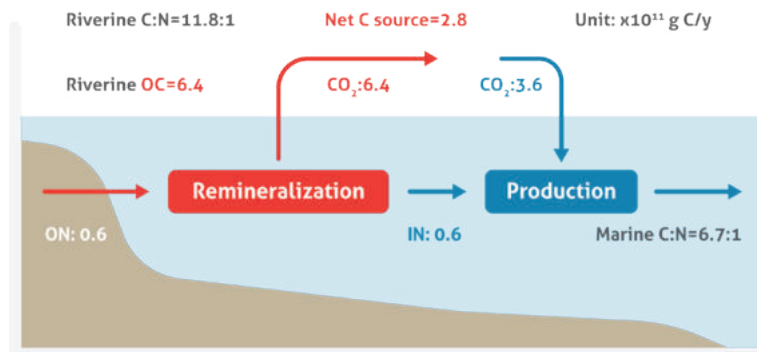

Figure 2.14: Conceptual diagram illustrating the switch from a coastal carbon source to a carbon sink (Source: Liu et al., 2020).



**Conventional viewed coastal carbon cycle and budget**



**Anthropogenic perturbed coastal carbon cycle and budget**

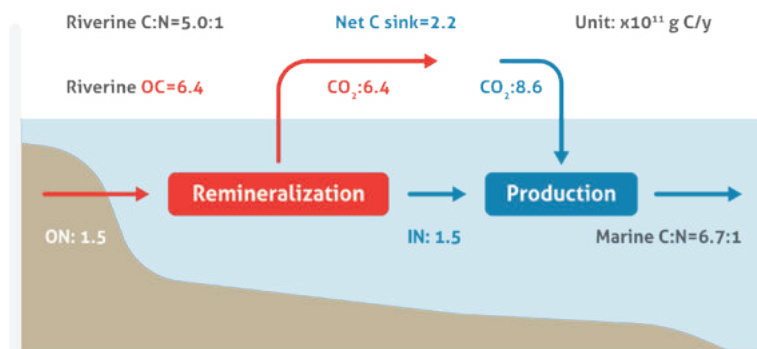

Where capital dredging is due to be carried out, and sediments released in a different sedimentation environment, one can estimate the impact on carbon sequestration by:

1. Assessing the reactive parts of carbon, phosphorus and nitrogen in the sediment that may be set free through pore water release, mineralization of labile organic matter, hence the reactive C/N, C/P and the C/fine ratios;
2. anticipating what fraction of the reactive components in the sediment is expected to be released due to the way the sediment is excavated, transported and disposed; this may or may not be sufficient;
3. comparing the reactive C/N, C/P and C/fine ratios with those in the new location, in order to determine whether there is an excess that may lead to additional primary production and sequestration of organic carbon or not.

### ***Sequestration efficiency of organic carbon***

An important concept for carbon cycles and nutrient cycles is the sequestration efficiency, which indicates how much carbon is sequestered with a finite amount of available fine sediments and nutrients and within a given time frame. Carbon sequestration is often indicated as carbon sequestered per hectare per year, but in situations where fine sediments and nutrients are limited, other definitions for efficiency may be relevant.

By shifting the balance between production and decomposition of organic carbon, for example by processes preventing or slowing down complete decomposition, organic matter can build up in the sediment, potentially leading up to long-term storage. Coastal wetlands tend to have a very high rate of carbon burial, which depends on four key factors (Macreadie et al., 2019):

- the rate at which organic carbon is produced (primary production) and decay;
- the amount of carbon available for burial;
- the sedimentation rate;
- preservation of buried carbon.

### **2.2.5 Inorganic carbon in relation to organic carbon**

Carbon is also present as inorganic carbon, not bound to organic matter but in the form of carbonates, e.g. calcite and aragonite. In fact, in the marine environment the pool of inorganic carbon is much greater than that of organic carbon. The most abundant form of inorganic carbon are shells and shell fragments made of carbonate – those of molluscs, arthropods and corals. Carbonate concretions can also be formed by bacteria that live on the stems of sea grass. The production of inorganic carbonate by organisms is substantial, as can be seen in coral reefs, and also in the numerous biogenic beaches that adorn tropical shores. These beaches are characterized by very white sand, that, depending on the source, consists of the fragments of shells, coral, foraminifera or nodules formed by bacteria on sea grass. Inorganic carbon content may vary from less than 5% to more than 90% in coastal sediments. Very high proportions of inorganic carbon is found in salt marshes, sea grass beds and mangroves, particularly where these are located near coral reefs or on carbonate substrates, such as limestone.

Inorganic carbon can be present as particulate inorganic carbon (PIC), such as shell fragments, and as dissolved inorganic carbon (DIC), i.e. different forms of dissolved CO<sub>2</sub>. In fact, the largest carbon pool is DIC in the deep sea. In addition to rocks made of calcium carbonate, another important mineral is dolomite, a calcium/magnesium carbonate.

The formation of carbonate by organisms produces CO<sub>2</sub>, initially in dissolved form, which can escape to the atmosphere as CO<sub>2</sub> gas. In fact, the presence of inorganic carbon indicates emission of CO<sub>2</sub>. Not much is known about the capacity of benthic organisms, such as bivalves, to produce carbonate shells, but the production of cockles in mangroves can easily surpass 10 tons per hectare per year, largely consisting of shells. Since coastal sediments and wetlands contain large amounts of carbonate forming organisms, their presence needs to be acknowledged in assessment of the carbon sequestration capacity of these systems.

Another poorly understood process is the dissolution rate of calcite or aragonite. Calcite can dissolve when the pH of sea water is reduced, sometimes caused by acids produced by the anaerobic mineralization of organic matter. In coastal wetlands, such as mangroves and salt marshes, the mineralization of organic matter appears to be the most important factor for the dissolution of PIC. Consequently, the mineralization of organic carbon and the inorganic carbon cycle are closely linked.

In coastal sediments and coastal wetlands, both processes, calcification and dissolution, take place. It is the balance between the two that determines whether it leads to net emission or sequestration of CO<sub>2</sub>. So far, only a few studies have looked into inorganic carbon and most of these have been directed at sea grass beds.

Since coastal wetlands accelerate the sedimentation of fine particles, there is often a net import of inorganic carbon, such as shell fragments. Studies show that sea grass beds, salt marshes and mangroves close to coral reefs or carbonate substrate, have large amounts of inorganic carbon in their soils - in these systems, most calcite and aragonite are allochthonous. These systems can dissolve more PIC than is locally produced by animals and bacteria, hence these systems possibly sequester more carbon indirectly than is estimated by solely the rate of photosynthesis. In fact, some studies imply that the inorganic carbon contribution may be 1.7 to as much as 20 times higher than that of organic carbon sequestration, especially where mangroves are established on carbonate substrate.

The sequestration efficiency of inorganic carbon is thoroughly different and highly complex. Crucial is the formation and dissolution of carbonates, which exchanges CO<sub>2</sub> in its soluble form, bicarbonate (HCO<sub>3</sub><sup>-</sup>). In the water column it exists in a dynamic equilibrium with atmospheric CO<sub>2</sub>. When CO<sub>2</sub> concen-

tration in the air increases, it leads to higher rate of uptake by the water. Consequently, a large amount of historic CO<sub>2</sub> emissions have been dissolved into the ocean. This in turn leads to ocean acidification, i.e. reduction of the pH, which has a myriad consequences for biogeochemical processes and marine life.

Coral reefs, shells and bacteria are the most prominent carbonate producing organisms, so inorganic carbon is largely related to the presence of animals. However, since all these animals depend on organic matter as food, the inorganic and organic cycles are strongly linked. Furthermore, most of the dissolution of PIC is caused by acids that are the result of anaerobic decay of organic matter in the presence of sulphur, leading to the formation of pyrite. Thus, pyrite is sometimes used as a proxy to determine carbon dissolution capacity. Both the formation of carbonates and their dissolution are strongly related to the organic carbon cycle. PIC can also be dissolved in sea water, especially when the pH is lower, but usually its contribution is limited, compared to that of the acid producing anaerobic decay of organic matter.

Shells, foraminifera, calcite producing bacteria abound in coastal wetlands and sediments. The production of carbonates can be so prolific that it leads to the formation of biogenic beaches that mostly consist of shell fragments, calcite concretions and more. Coral reefs also produce large amounts of carbonates and, the material can also be transported and form beaches. There, some dissolution takes place, but may be limited. More dissolution takes place in coastal wetlands, since, in these environments, anaerobic decay of organic matter occurs. Such anaerobic decay produces DIC that is outwelled during low tides. The DIC outwelled is especially large in the case of mangrove forests that grow on calcareous substrates. Here, the transported and locally produced organic matter, and its subsequent decay under anaerobic conditions, dissolves more PIC than is produced. Hence, there is a positive outflow of DIC. Frequently,

this DIC results in additional outgassing of CO<sub>2</sub> in nearby creeks or estuaries. Whether the outwelling of DIC leads to additional emissions or additional sequestration, due to the binding of CO<sub>2</sub> when PIC is dissolved, depends on total alkalinity (TA).

The degree to which TA and DIC are increased depends on the chemical process that leads to decay of PIC. Carbonate dissolution and sulphate reduction, coupled to pyrite formation and burial, increase TA and DIC in almost stoichiometric ratios. Denitrification yields slightly less TA than DIC and aerobic respiration yields far less TA than DIC. In a study of the impact of riverine inputs the following was stated:

- Dissolved inorganic carbon (DIC) input by the river: half is exported to the sediment as CaCO<sub>3</sub> and the other half is outgassed as CO<sub>2</sub> in model equilibrium state, leading to outgassing of around half the DIC input. This assumes an equilibrium of 1 mol TA to 1 mol DIC, which is nearly always the case.
- tDOM (terrestrial DOM) enters the ocean with a very high C/P ratio, which exceeds ocean sediment export, leading to equilibrium outgassing of CO<sub>2</sub>, in the order of nearly the tDOM input, but this is mainly due to the very high C:P ratio. DOM that enters the ocean due to outwelling from coastal wetlands has a lower C:P ratio, but may still lead to substantial outgassing of CO<sub>2</sub>.
- Dissolved inorganic phosphorus (DIP), when biologically available, leads to 122 times as much carbon binding (assuming C/P of 122:1 for ocean primary production). When DIP and DIN are transformed into organic matter, the alkalinity increases, but this leads only to a very small additional carbon uptake, which can usually be neglected.
- To this may be added the outflow of POM from the vegetated wetland areas. POM from mangroves, salt marshes and sea grass beds usually has a carbon to nitrogen ratio that is slightly higher than the Redfield ratio, so the mineralization of this organic material leads to some outgassing of CO<sub>2</sub>.
- Based on the inorganic carbon balance, the outflow of DIC typically means half of it is subject to outgassing as CO<sub>2</sub>. Dissolving carbonates consumes 0.6 CO<sub>2</sub>.)

The processes involved are very complex and show great temporal and spatial variability. So far there is not one study that looked into all relevant processes and components in order to define the carbon sequestration rate of coastal sediments and wetlands.

### 2.2.6 Processes contributing to sediment organic carbon (SOC)

Several recent studies investigated the key factors that determine the levels of sediment organic carbon (SOC) in mangroves, salt marshes and sea grass beds, by looking at the difference not only between adjacent locations, but also within a coastal wetland system. The studies that undertake a global comparison, point towards climate, geomorphology and coastal forms, and tides as important factors determining SOC. The locally-focussed studies indicate that tide, distance to open water, sediment texture and sedimentation rate are important. Specific studies indicate, however, that many more factors play a role, among which nutrient availability, black carbon content, tephra, etc.

#### *Regional factors*

Regional factors operate on scales of several to several hundred kilometres, much greater than a single coastal project. They largely explain differences in carbon stock and sequestration rate (potentials) between similar coastal ecosystems. Carbon stocks vary between mangrove systems worldwide by a factor of 20, and the difference between salt marshes, mud flats, marine coastal sediments – at least by a factor of 10. Important regional factors include:

- Climatic regime (rainfall, evapotranspiration, air temperature) largely determines the range of plant species, the intensity of primary production (when nutrients are available), and decay processes. Seasonal changes (dry/wet, cold/hot) cause considerable variations in organic carbon in the horizons of soils and sediments, which needs to be taken into account when calculating carbon stocks based on field data. Climate also drives salinity in soils and estuaries and influences primary production, as well as decay. Estimations of the permanency of carbon stocks in sediments and coastal systems need to consider the incidence of major storms.



Photo: Adobe Stock©

- Oceanic regime and currents (upwelling zones, water temperature) affect nutrient availability, zones with limited P and N and water temperature and therefore pelagic and benthic primary production. These, in turn, determine the influx of organic C and nutrients into intertidal ecosystems and coastal sediments.
- Sediment type (texture such as clay and mud content,  $\text{CaCO}_2$  content, nutrients in organic and inorganic forms) and availability depend on rivers, as well as on coastal erosion and ocean currents. The sediment type determines nutrient availability and the texture of soils, substrate and sediments and therefore essential processes that form, decay and sequester carbon. Sediment regimes determine the short and long-term availability and therefore the permanency of sediment dependent coastal ecosystems, such as salt marshes and mangroves.
- Tidal flows (micro-tidal and macro-tidal) transport sediments and affect rates of sedimentation and soil formation, as well as the natural width and gradients, inundation, salinity and vegetation in ecosystems.
- Sea level (rise), including eustatic movements, the minimal yearly increase and the 18.6 year nodal cycle, which influence regional sediment availability and rise in sea and related groundwater levels to which coastal wetlands need to adjust. On a regional scale, there are marked seasonal variations, modulated by persistent winds, such as monsoons. These seasonal differences may lead to continual king-tides that influence soil processes and lead to seasonal variations of carbon stocks in soils in intertidal areas.

These factors are important for translating field data into carbon stocks, taking into account temporal variations and for explaining the regional variation between carbon stocks on a larger scale. These factors do not explain the significant differences within a coastal ecosystem and neither do they offer opportunities to optimize the ecosystem-based GHG footprint calculation of a hydraulic engineering project.



### **Local factors**

The variation in carbon stocks within a coastal ecosystem, such as a salt marsh or mangrove forest, is mainly dependent on factors that determine sedimentation and soil formation locally:

- Relative sea level rise, the combined effect of sea level rise and localized land subsidence due to groundwater abstraction. This determines sediment availability and sediment balances, local sedimentation conditions, ecological succession, soil formation processes.
- Coastal morphology and morphological processes such as accretion and sedimentation. Eroding, stable and accreting coasts, estuaries and deltas show very different timescales for soil formation and the appearance of vegetation, due to difference in sedimentation, substrate conditions, seasonal salinity intrusion, etc.
- Wave exposure, which determines conditions for benthic communities, vegetation and sedimentation, and in combination with sediment availability, erosion and accretion.
- Sedimentation conditions are a function of wave patterns, vegetation, sediment type and local availability, tidal regime and relative sea level rise.
- Substrate, arising from parent materials, sediment availability and sedimentation processes. Biomass formation by plants on coarser textured soils is low, but decay is higher. The decay of organic matter on carbonate rich substrates is limited, so carbon content of these soils is high.
- Vegetation type and benthic communities determine the production of organic carbon, the functioning of soil-based nutrient pumps, local wave climate and sedimentation.
- Soil formation is the product of substrate, vegetation, land use, tidal regime, sediment composition and sedimentation rates, relative sea level rise, and the burial activity by animals. These determine not only the burial and final sequestration of organic carbon, but also the potential emission of methane (CH<sub>4</sub>).
- Tidal pumping/proximity to open water, the infiltration and outwelling of nutrients, DIC, DOC is determined by tidal range and texture, and is most intense closer to open water such as tidal creeks.

Some of these factors, namely sedimentation conditions, tidal pumping and sedimentation rate are discussed in more detail in the next section.

### **2.2.7 Processes that contribute to emission of carbon as methane**

Organic carbon can be emitted as greenhouse gas CO<sub>2</sub> or as the stronger greenhouse gas methane (CH<sub>4</sub>). Methane is microbially produced in environments without oxygen, where it may be released from the sediment as bubbles (ebullition) or gradually dissolves and is released to the atmosphere at the air-water interface. CH<sub>4</sub> emissions tend to be low in saline waters of tidal wetlands, with a tipping point around a salinity of approximately 10 to 15. This is due to the fact that the methane producing microorganisms are outcompeted by sulphate-reducing bacteria and archaea, since sulphate is omnipresent in saline waters. In less saline ecosystems, CH<sub>4</sub> emissions are highly variable and can be rather high (Bridgham et al., 2013; Poffenbarger et al., 2011; Rosentreter et al., 2021).

Overall, coastal systems and open ocean contribute on average  $33.2 \pm 37.6$  Tg CH<sub>4</sub> yr<sup>-1</sup> (Rosentreter et al., 2021), which is only 10% of what the inland waters produce ( $398.1 \pm 79.4$  Tg CH<sub>4</sub> yr<sup>-1</sup>). Within the marine environment, highest CH<sub>4</sub> fluxes are observed in the continental shelf ( $17.2 \pm 34$  Tg CH<sub>4</sub> yr<sup>-1</sup>), followed by coastal aquaculture ponds ( $5.9 \pm 15.1$  Tg CH<sub>4</sub> yr<sup>-1</sup>). High CH<sub>4</sub> fluxes are attributed to continental shelf zones, due to the high abundance of gas seeps and plumes in these systems. However, per unit area, the CH<sub>4</sub> fluxes from the continental shelf ( $12.1 \pm 19.9$  mg CH<sub>4</sub> m<sup>-2</sup> d<sup>-1</sup>) are much lower compared to vegetated coastal ecosystems, including mangroves ( $29.0 \pm 18.2$  mg CH<sub>4</sub> m<sup>-2</sup> d<sup>-1</sup>) and salt marshes ( $99.5 \pm 75.5$  mg CH<sub>4</sub> m<sup>-2</sup> d<sup>-1</sup>) (Rosentreter et al., 2021). Yet, all of the above emissions are dwarfed by emissions from coastal aquaculture ponds, which, despite high variation, are estimated at  $686.8 \pm 1774.5$  mg CH<sub>4</sub> m<sup>-2</sup> d<sup>-1</sup> (median =  $73.2$  mg CH<sub>4</sub> m<sup>-2</sup> d<sup>-1</sup>). Disturbed vegetated coastal ecosystems tend to emit more CH<sub>4</sub> than natural systems. Due to its high variation, it is difficult to estimate CH<sub>4</sub> fluxes from vegetated coastal ecosys-

tems, which presents a challenge for making carbon offset decisions in these blue carbon wetlands. Further research is needed in order to elucidate the various pathways, and also understand their temporal and spatial dimensions globally.

### 2.2.8 Hydro- and morphodynamic conditions

#### ***The tidal pump in the intertidal zone***

As indicated in the overview, sediments in the intertidal zone are in a very special position. These sediments are frequently inundated and receive a large influx of water, nutrients and organic matter brought in by the tides. They are also frequently drained, leading to the outwelling of soluble DIC, DOC and nutrients. This process of outwelling may represent more than 50% of the lateral flux from a salt marsh or mangrove to the sea. The tidal pump is stronger with increasing tidal amplitude and coarser texture of the substrate.

The tidal pump is stronger closer to creeks and the shoreline, since the variation in groundwater levels reduces inland. The flushing rate in mangrove was observed to be in the order of 23 cm/day leading to a large release of dissolved CO<sub>2</sub>. Another study indicated similar exchange rates for a salt marsh, and noted very large temporal variability with tides, between years and between locations within the marsh. Also, the presence of animal burrows can greatly enhance the flushing capacity of the tidal pump. For the interpretation of soil carbon data, it is important to know whether the soil sample was taken within the zone that is subject to tidal pumping.

Outwelling depends on tidal amplitude and sediment texture. In the case of very muddy and clay-rich sediments, such as mudflats, infiltration and outwelling will be very limited. However, in substrates that contain more sand, infiltration is high, as is outwelling and any related processes are more intense. In sandy substrates, the depth to which the tidal pump is active is also larger. Because of these processes, there is a marked gradient from shore to inland in most coastal wetlands, with very large differences in organic carbon content in the soils.

#### ***Tidal amplitude and waterlogging***

Waterlogging creates anaerobic conditions and results in limited decay of organic matter. The flow of mineral substrates is limited and the contribution of roots, litter and stems to soil formation is higher. One of the key reasons that backswamps have higher SOC is precisely the limited drainage of these soils. Waterlogged soils are rich in organic matter and, in backswamps, even peat layers may develop.

At a greater distance from the sea and tidal creeks, the influence of the tides reduces and soils are less well drained, independent of the tidal amplitude, since even at low tide, groundwater levels remain high. This is especially the case in soils with a high clay and silt content.

#### ***Resuspension and disturbance of surficial sediments by tides, storms, shipping and bottom trawling***

Resuspension and disturbance of surficial sediments by tides, storms, shipping and bottom trawling depends on the closure depth. The closure depth is a morphological concept that indicates the depth to which waves may still move sediment. The closure depth is time dependent. Within a year the closure depth changes with the depth to which seasonal storms can move sediment. Once every few decades, a much larger storm event expected to occur within this time frame, will increase the closure depth. Major storms that occur once every 20 or 50 years determine the stability of sediments, hence also the sequestration of carbon in surficial sediments. Annual storms that also move, resuspend and reoxygenate sediments, lead to decay of labile organic matter, and increase levels of recalcitrant organic matter.

Frequent disturbance by bottom trawlers also reduces organic matter content, because of aerobic decomposition. Additionally, it prevents the development of benthic communities, so primary production is also limited, as may be bioturbation. In this respect, the effects of bottom trawling and frequent sediment resuspension by storms are very similar.

Figure 2.15: Sediment passport

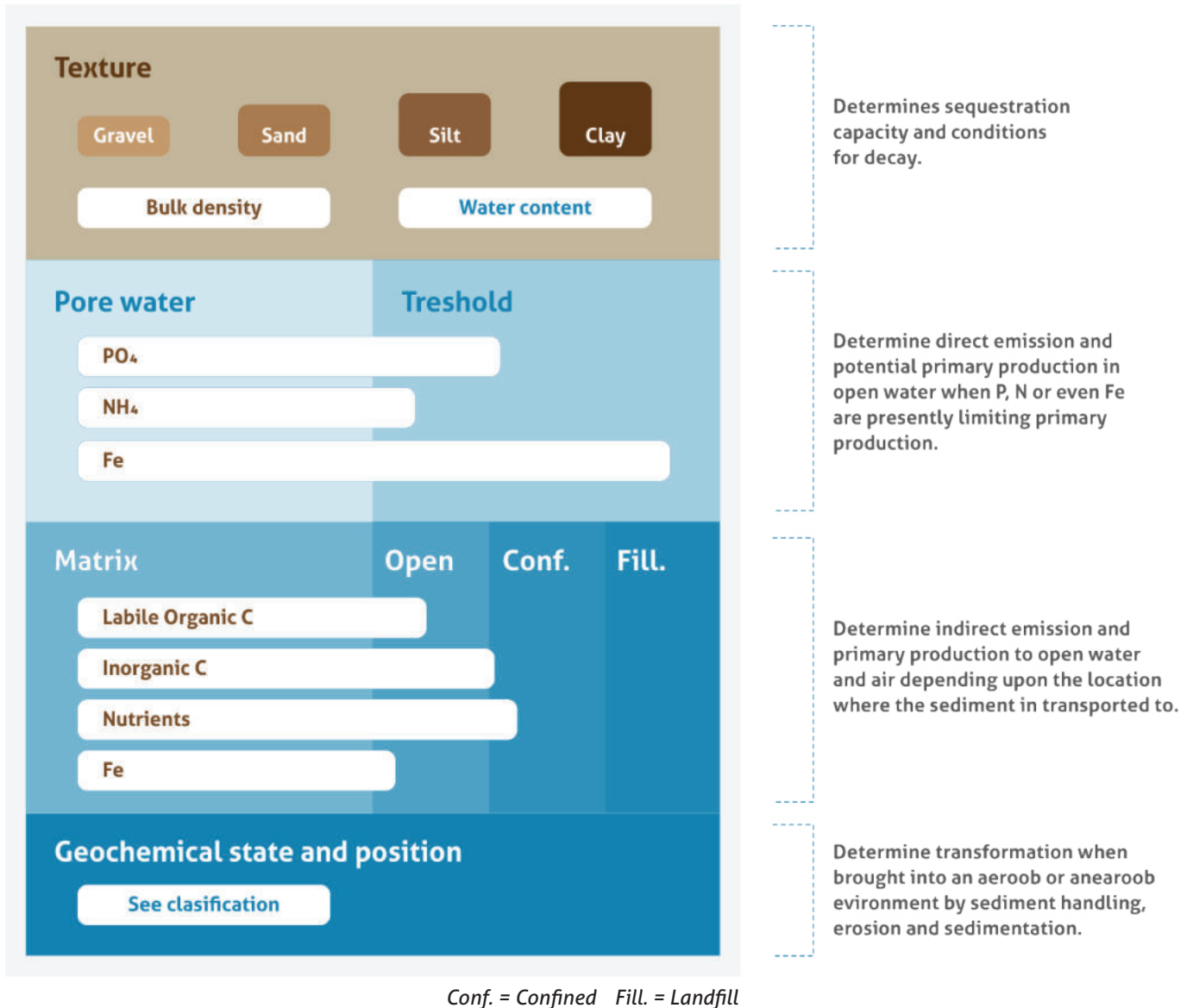

Shipping activities also disturb sediments in navigation channels and harbour basins. The turbulence of propellers can resuspend sediment several metres below the keel of the ship. Moreover, navigation channels and harbours trap large amounts of fines and organic matter, decomposition is intense and a large proportion of the organic matter may be recalcitrant.

**Sedimentation rate**

Another important factor that determines organic carbon content in soils and sediments is the sedimentation rate, which can be affected by coastal hydraulic structures. A higher rate usually implies that less time

is available for aerobic decay of organic carbon. At the same time, a higher rate of sedimentation usually implies that organic carbon is diluted by substantial amounts of mineral sediments, meaning that a larger part of the organic carbon is sequestered, even if SOC is low but the percentage of labile organic matter is high.

High natural sedimentation rates are usually observed in deltas and accreting shorelines. Most established coastal wetlands show moderate to low sedimentation rates, usually in line with (relative) sea level rise, in the order of 5 to 10 mm per year. This usually gives ample time for the transformation of labile forms of



organic matter. As a consequence, organic matter that is buried deeper in the soil consists largely of non-reactive organic carbon.

Wetland creation and restoration projects, sand pits and navigation channels are typically characterized by very high sedimentation rates.

## 2.3 Reducing complexity

As explained in previous sections, carbon sequestration is complex. For practical purposes, we reduce that complexity in three ways:

1. use a sediment passport which defines all sediment characteristics that are important for carbon sequestration;
2. focus on long-term carbon sequestration;
3. consider fine sediments.

### 2.3.1 Sediment passport

We wish to introduce the concept of a sediment passport (Figure 2.15) that defines all sediment characteristics important for carbon sequestration. The following sediment characteristics are part of the sediment passport, and should be inventoried:

- Physical characteristics: grain size distribution (sand, silt, clay), bulk density and (pore) water content;
- Chemical characteristics of pore water: nitrate, ammonium, phosphorus, DOC, DIC, TA, salinity, of which ammonium and phosphorus are the most important;

- Organic carbon characteristics matrix: organic C, percentage labile C, reactive C/N and C/P ratios. Whenever OC content is more than 0,5%;
- Mineral characteristics matrix: biologically available nutrients, minerals that influence decomposition and sequestration of carbon, such as Fe, Ca, Mg, S, of which Fe may be the most important.
- Geochemical address/position, this is aligned with the sedimentological position in the coastal landscape.

Any of the sediment characteristics in the sediment passport can be changed by a coastal engineering project, which may affect carbon emissions and sequestration.

#### ***Physical characteristics sediment***

Clay/silt content seems to be a good proxy for predicting organic carbon content, since there is evidence for a strong correlation between clay/silt content and the percentage of organic carbon in deeper soils. This correlation is notably consistent for deeper sediments below the active top layer, but tends to vary between regions, due to mineral characteristics and input of organic carbon.

#### ***Chemical characteristics of pore water***

DOC, DIC, TA, salinity and soluble forms of nitrogen and phosphorus can often be found in high concentrations in the pore water of sediments. When these sediments are dredged, most of the pore water is released, which has an impact on (local) prima-



ry production, the outgassing of methane and  $\text{CO}_2$ . These are direct effects, sometimes substantial when compared to the direct emissions of engineering works, albeit small compared to the potential effects of carbon and nutrients that may be released from the sediment itself. Most soluble forms of phosphorus and nitrogen are biologically available. The biological availability of nutrient in DOC depends on its reactive fraction and related C/N and C/P ratios. As discussed in the previous chapter, other minerals such as phosphorus, ammonium, and in specific situations, also free iron can have a substantial impact by driving primary production.

### ***Organic characteristics matrix***

We have outlined how organic carbon can be incorporated into both labile and recalcitrant forms of organic matter, because of its strong (chemical and mechanical) binding to fine sediments or to humic acids. Recalcitrant forms of carbon, such as black carbon, are normally abundant in deeper, older sediments, but act neutral when released by dredging or erosion. Also frequently reworked sediments, including nautical dredging sludge, which may contain high percentages of recalcitrant carbon. In order to define the potential impact, one needs to know what fraction of the organic matter is labile and will decay, releasing carbon and nutrients. C/N and C/P ratios determine whether decay will also lead to outgassing of  $\text{CO}_2$ .

### ***Mineral characteristics***

The anaerobic decay of organic matter depends strongly upon the presence of sulphur, iron, calcium, and manganese. Iron is also important for the sequestration of carbon. We know from various studies that there is a large difference in the organic carbon content of (mangrove) soils situated on carbonate substrates and that high carbonate content does have a large effect on the dissolution of carbonate and outwelling of DIC and TA.

### ***Geochemical address/position/sedimentation/soil environments***

The presence of oxygen is the most important factor to be considered. Aerobic conditions dominate most top-soils and morphologically active surficial sediments, while deeper sediments are largely anaerobic. For top-soils and surficial sediments, a distinction can be made whether the availability of oxygen is due to drainage conditions, bioturbation, morphological dynamics or hydrologic flow. In a special position are those sediments and soils that actively partake in the tidal pump, so are present in the intertidal zone, are frequently or periodically inundated, and are subjected to a cycle of infiltration and drainage, leading to outwelling of dissolved forms of carbon and nutrients.

### 2.3.2 Long-term carbon sequestration

The carbon cycle is subject to many processes and fluxes. Most study efforts were directed towards quantifying carbon stocks and calculating sequestration rates. However, this exercise is complex because of temporal variations in the intensity of processes due to tides, seasons, rainfall and drought periods, variation in river discharge, occasional storms, inter-annual variations in climatic conditions, long term trends in nutrient availability, management and more. Most of these processes are not very relevant on time scales of 20 to 100 years. The stability of soils and sediments that contribute to carbon sequestration and also of recalcitrant organic matter may be more important for assessment of the long-term sequestration potential of coastal wetlands and sediments. Thus, we focus on conditions and trends that determine long-term carbon sequestration and on the final, or, at least, long term "resting places" of organic carbon, which are in most cases stable soils and sediments.

There are many trends, incidents and human activities that can disturb carbon stocks and sequestration rates over the lifetime of a coastal engineering project, assumed to be from 20 years to several decades, such as:

- A reduction in sediment budgets, caused by sand mining in rivers or close to the coast, upstream damming, blocking of longshore transport and the combination of land subsidence and sea level rise. Deltas and lowlands, which depend on fluvial inputs, are particularly susceptible to this. As a consequence, coastal steepening and erosion can occur, and coastal wetlands can be lost;
- Relative sea level rise, the combination of sea level rise and land subsidence may also affect the ability of coastal wetlands to keep pace with sea level rise, with the consequence of waterlogging and eventually the release of carbon and/or emission of methane. Particularly, coastal wetlands, such as mangroves, in microtidal settings are susceptible to this, since the influx of mineral sediments is often limited. The first response may be enhanced root formation but eventually the vegetation can no longer keep up. Waterlogging in wet climates can decrease salinity in soils, which can cause additional formation of methane;
- Changes in nutrient availability. Many coastal wetlands are situated in areas with substantial influx of nutrients from urban and agricultural areas. An in-

crease in nutrient input by untreated wastewater can increase the capacity of a coastal system to sequester carbon, partly because the incoming POC and DOC are characterized by high C/N ratios. However, this is expected to be temporary, because of efforts to reduce pollution;

- Incidental storms can erode coastal wetlands and sediments. Most of these sediments are redeposited, but, while resuspended, labile organic matter decomposes, and some outgassing of CO<sub>2</sub>. It should be noted that a storm that erodes 5 cm of sediment, may, in doing so, resuspend sediment and organic carbon that was sequestered over 10 to 50 years, depending on sedimentation rates.
- Major storms, by the action of waves and wind, may fell mangrove vegetation. The felled logs subsequently decompose, leading to the emission of CO<sub>2</sub> and also significant quantities of methane.
- Major droughts can cause the dying off of vegetation in the highest areas that are only inundated occasionally.

Relevant trends can be difficult to identify if they are gradual, but nevertheless, such trends are significant on longer time scales. Sea level rise is an important factor in sedimentation rates, sediment budgets and balances, conditions for soil processes and its impact on carbon sequestration in wetlands has been studied. However, other important trends are land subsidence, river discharge and the related discharge of sediments, coastal erosion and accretion, nutrients, especially in relation to eutrophication of coastal waters and rivers, since these determine nutrient input and primary production. Additionally, any legal protection of coastal wetlands and the physical protection of coastlines needed to safeguard coastal wetlands needs to be considered.

Whether a location can be regarded as a final or stable resting place also depends on its morphological stability with respect to major storm events. For coastal sediments, the influence of major storms may be indicated by the closure depth. There are examples from the Baltic Sea that carbon accumulated over decades in surficial coastal sediments was re-released by a major storm. Therefore, on longer time scales, stability needs to be assessed against the occurrence of extreme weather events, including major storms, floods and possibly droughts.

In addition to carbon that is securely sequestered in stable soils and sediments, one must add the standing biomass in the form of vegetation, which exists in a dynamic equilibrium of growth, decay and (forestry) management. Besides, the standing biomass of algae in the ocean, which very much depends on the nutrients available for their growth, also needs to be added – temporary algal blooms are not relevant, but the average long-term sequestration in algal biomass is. Furthermore, the amount of carbon present in dissolved form in deeper ocean water is, in fact, the largest known carbon pool.

An assessment should not only cover organic carbon sequestered in soil, sediments, biomass and dissolved forms in ocean waters, but also the net emission to the atmosphere of methane and  $N_2O$ , both of which are potent greenhouse gasses. The amount of methane and  $N_2O$  gas cannot be deduced from soil and sediment analyses, but still can, in certain environments, represent a considerable  $CO_2$  eq emission.

For an initial assessment of the long-term sequestration of organic carbon, our focus needs to be on:

#### **Coastal wetlands:**

- a. The longer-term sequestration of organic carbon in soils of coastal wetlands which depends on local production and influx of organic carbon, sedimentation rates, and therefore on relative sea level rise, and soil conditions that determine decay, including the production of methane gases which indirectly depends on the management and use of mangroves and salt marshes.
- b. The dynamic long-term presence of organic carbon in wetland vegetation and benthic algae depends on biomass at its climax state, and indirectly on management.
- c. Emission of methane due to anaerobic decomposition and emitted from soil and soil/water interfaces.

We do not include  $N_2O$  since its contribution is expected to be very small.

#### **Coastal waters and sediments:**

- d. The longer-term sequestration of organic carbon in shallow coastal sediments depends on sedimentation rate, sediment composition and conditions that determine decay, such as sediment disturbance. In shallow seas, bottom fisheries also have an impact on decay and probably also long-term sequestration.
- e. The dynamic long-term presence of organic carbon as biomass in the form of (pelagic and benthic) algae.
- f. Emission of methane due to anaerobic decomposition of organic C from soil/water interfaces. The relevant water/air emission depends on depth. With greater depth, less  $CH_4$  escapes to the atmosphere, since it is consumed in the water column.

#### **Ocean and marine sediments:**

- g. The dynamic long-term biomass of organic carbon in algae. This term is similar to biomass in wetlands, but mainly consists of living algae. Their biomass depends mainly on the availability of nutrients, but the amount of carbon they store depends on the type of algae.
- h. Long-term equilibrium DIC stored in ocean waters. As discussed, intertidal wetlands export high quantities of DIC which may contribute to long-term sequestration in combination with TA, although this is speculative and still uncertain.

Methane emission to the air from deep sea sediments is probably very small and therefore not included.

#### ***Include all steps that lead to long term sequestration***

Long-term sequestration of organic C in the coastal seascape is always the result of the following sequence:

- Primary production of organic C, or external input of organic C. The external input can be marine, or terrestrial from rivers or even coastal erosion. For coastal sediments and coastal wetland organic C can come from lateral transport from nearby blue carbon wetlands.
- Burial in sediments, where sediment input and hydrological conditions, sea level rise and land subsidence can all play a role.

- Decay of organic C, which depends on hydrological conditions, the presence of oxygen and, in the case of anaerobic decay, other electron acceptors, in addition to time and bioturbation.
- Resulting sequestration, which may only be temporary if conditions change, resulting in resuspension of sediments and erosion.
- Final sequestration of organic C, in stable environments, in soil and sediments, or as DIC in deeper ocean waters.

### ***Incorporate relevant lateral fluxes***

These are powered by rivers and ocean currents, and exchange carbon and nutrients. Important factors are:

- Sediments, with a distinction between sand, for building habitats, and fines with their ability to promote sequestration of organic carbon. Without sediments, no coastal wetlands would develop.
- Organic C, of terrestrial or marine origin the percentage of labile organic C is critical. Imported Organic C is mostly POC, while exported organic C can be POC or DOC. A major part of both the imported and locally produced organic C is mineralized and exported as DOC, due to tidal pumping with groundwater/pore water. In fact, only a small part of the organic matter arising by primary production in salt marshes, mangroves and sea grass beds is sequestered locally in plant material and soils.
- Nutrients, with a critical distinction between the roles of P and N, determine nutrient limitation of primary production in adjacent coastal waters and intertidal wetlands.
- In addition, minerals critical to decomposition (e.g. Fe) or a characterization of the sediment type.

Exchange and input from rivers, ocean currents, coastal erosion and longshore currents may be considered as external factors, but the exchange between coastal wetlands and coastal sediments is a form of interaction, mainly driven by tides. Over middle to long term, external input may exhibit certain trends, especially in the levels of nutrients and sediments, possibly caused by water quality management, damming,

mineral mining, land subsidence that upsets sediment balances, etc.

### ***Include important regulating factors***

The combination of input and exchange with conditions that determine production, burial and transformation of organic carbon, determine the final carbon sequestration. Important conditions are:

- Climate, particularly temperature, rainfall and seasonality, and, with respect to the long-term morphological stability of wetlands and sediments, storm incidence.
- Relative sea level rise, the combination of sea level rise and local land subsidence is critical to sediment budgets, sedimentation rates and conditions that promote decay.
- Hydrological, such as wave energy and direction, tides and longshore currents. It may be necessary to include oceanographic phenomena such as upwelling zones, or flow patterns on the continental shelf/in nearby coastal waters.
- Hydrology, which refers to groundwater conditions and dynamics, salinity variation etc.
- Management of mangrove forestry, bottom fisheries in coastal waters, because of their impact on burial, and decay of organic matter in sediments.

All carbon pathways include numerous steps leading to sequestration. The question is, however, whether the carbon that is sequestered will still be buried 20 or 100 years from now. This depends on continuity in conditions, such as sediment input, sea level rise, and sometimes on the occurrence of major storms or tsunamis. An additional question is whether land use and management is predictable over longer time periods.

We do not necessarily need to understand the entire processes in detail, as long as there is a clear connection between the conditions and inputs for long-term sequestration of carbon, in its different forms. With that knowledge, we will be able to predict how an engineering project may alter local conditions, input variables and sequestration.



The process is extremely complex and the flux diagram is a simplification, not least because we lack sufficient knowledge of certain components necessary to make quantifications or even well supported guesses. The scheme does, however, help to identify major gaps in information.

Nevertheless, there are some factors of which we can be more certain or that can be obtained by simple field measurements such as:

- Carbon stocks, in terms of (maximum) biomass in certain types of wetland vegetation, but less so in coastal sediments.
- Carbon accumulation rates for certain types of wetlands and coastal sediments in specific regions.
- The relationship between soil texture/fine content and percentage of carbon, possibly with a distinction between sediment types (e.g. carbonate based, etc.).
- Some indications of C/N, C/P ratios in different sedimentation habitats.
- Scarce information on methane emission by different types of ecosystem and lateral export of DIC and TA.
- Scarce information about the quantity of inert organic carbon in different environments.
- N or P limitation in certain coastal waters.

### 2.3.3 Fine sediments as proxy for sediment organic carbon

Organic carbon content often correlates with the presence of fine particles, whose ability to bind organic carbon is strongly linked to the abundance of specific mineral classes such as smectite clays, metal oxides or tephra, and much less to total mineral surface area (LaRowe (2020).

Fine sediments bind organic carbon in a way that further mineralization is limited, or, within a given time scale, prevented. In finer sediments the long term sequestration potential is higher, achieved both by binding and by reducing oxygen availability for the aerobic mineralization of organic matter. This is also the reason why older sediments often show a direct

correlation between the percentage of fine particles and the percentage of organic matter.

There appears to be a consistent relationship between fine sediments, such as clay and silt, and organic carbon content in coastal sediments and wetlands. This is often explained as follows:

- Fine sediments prevent oxygenation of sediments, creating anaerobic conditions, which slows down the mineralization of organic matter.
- Fine sediments create conditions that also favour the sedimentation of fine organic matter.
- The high specific surface of fine sediments enables strong mechanical attachment to organic matter, so decay is prevented.
- The minerals in fine sediments, such as iron, can form strong chemical bonds with organic matter, further preventing decay.

Since sediments differ in mineral content, the link between organic carbon and fines is best understood on regional scales. Sediment characteristics are especially conducive to long term sequestration, thus the association between organic carbon and fines is stronger for deeper and older sediments. As soon as this relationship C/fines is established, extrapolation of carbon stocks becomes easier.

### 2.3.4 Limitations to our knowledge

Even though it is possible to build a general overview of all factors and variables, our detailed knowledge of processes is often limited. Limited, but nevertheless important knowledge relates to:

- The carbon sequestration potential of sand pits in different conditions.
- How to assess the sequestration capacity of released nutrients in coastal waters, in the long term, with respect to reactive C/N and C/P ratios.
- How to incorporate inorganic carbon in ecosystem-based carbon footprint calculations and how dissolution of PIC is affected by land reclamation works.



## 2.4 Conclusions

The essence of this chapter is that coastal ecosystems are open systems, in which lateral fluxes alter the overall sequestration capacity, that the major share of organic carbon is stored in soils and sediments, and that the organic and inorganic carbon cycle are strongly intertwined, and linked to the nutrient cycles.

From a morphological point of view, coastal landscapes show large differences, ranging from rapidly accreting deltas to barren sandy coasts. Some coastal wetlands act as a filter of sediments, nutrients and organic matter that originates from rivers and longshore currents, and also act as a transformer, converting nutrients into biomass, subsequently transformed into POC and DOC, a process where organic matter is partly transformed into recalcitrant organic matter. Only a small part of the net primary production is sequestered in their soils, the larger part of POC and DOC is exported to nearby areas. Coastal wetlands also act as transformer for carbonates, initially formed using dissolved CO<sub>2</sub>, which may be later re-released, from carbonates formed on site or brought in by coastal processes, which may also be dissolved and precipitated, resulting in either sequestration of carbon or the release and outwelling of DIC.

The combination of all these processes leads to marked differences in organic carbon stocks and organic carbon sequestration rates. Most of the organic carbon is buried and contained in sediments, stocks can be inventoried and well understood. However, sequestration rates are much more difficult to assess, because of the numerous lateral pathways of carbon in- and outflow, and its different forms. Specifically, the role of inorganic carbon is often poorly described.

Importantly, however, most recent sediments contain large amounts of labile organic matter that can decay rapidly under oxygen-rich conditions, leading to the outgassing of CO<sub>2</sub> that may far exceed the direct emission of CO<sub>2</sub> by engineering projects.

### *Main findings important for Hydraulic Engineering projects in coastal ecosystems*

Coastal engineering projects have impact on sediments, directly by dredging or indirectly by changing hydraulic and hydrological conditions. Sediments are key to the sequestration of carbon. Fine sediments, such as clay and silt in particular, play a major role in the oxygen availability and long-term sequestration of organic carbon. Based on how carbon cycling in coastal ecosystems works, a hydraulic engineer needs insight in at least the following three perspectives in order to plan a project with carbon-friendly design:

- 1. Ecosystem-based:** the processes that determine production, burial, decay and sequestration of organic matter in open coastal systems. With sufficient knowledge of the ecosystem where a hydraulic engineering project will be situated, one can predict which fluxes will be affected (i.e. hydrodynamics and thereby sedimentation and thus carbon burial).
- 2. Long-term sequestration:** the emphasis on long-term storage of carbon in stable positions, most relevant at the time scales important for climate action. Focus on carbon in the sediment, because much of the long-term carbon storage in marine systems happens in the sediment.
- 3. Sediment-centred:** the characteristics of sediments and processes that determine sedimentation rates and release of carbon and nutrients from sediments. Focus here is on organic carbon content of the sediment to be disturbed and the quality thereof. It is this organic carbon that may be lost upon disturbance due to exposure to oxygen, the potential total loss depending on its degradability.

Using these three perspectives we were able to simplify the complexity of organic carbon cycling in coastal systems and distilled the most relevant information that needs to be assessed in the form of a 'sediment passport'. The required information can be retrieved as part of standard field campaigns that are needed to underpin the design and execution of any engineering project

## Chapter 3

# Impact of coastal engineering projects on the carbon seascape

### 3.1 Introduction

The four main types of coastal engineering project are land reclamation, port development, wetland restoration and coastal protection. This chapter gives a description of the different types of projects, their associated carbon emissions and how these emissions can be reduced. Any coastal engineering project, such as a new harbour, consists of one or more interventions, such as excavation of the harbour basin and access channel, construction of harbour dams and quay walls. We discuss how these affect the carbon seascape, with a focus on their impact on sediments and sedimentation. Other marine engineering projects, such as wind parks, oil platforms, nor agricultural projects such as the conversion of coastal lowlands into rice fields, oil palm plantations or aquaculture ponds, are not considered (because they are out of scope, not because they have no GHG emissions).

This chapter is mainly intended to familiarize non-engineers with engineering activities. For hydraulic engineers, the link between the interventions and the carbon seascape might be of interest and how the impact on carbon emissions can be reduced. This can be achieved by thoughtful handling of sediments and the integration of coastal wetlands into the design. What will work depends on the available engineering options, the related costs and environmental effects. Note that we focus on ecosystem-based CO<sub>2</sub> emissions and do not discuss the direct CO<sub>2</sub> emissions of works and materials. For each type of project, we indicate ways to minimize CO<sub>2</sub> emissions and maximize carbon sequestration.

### 3.2 Types of coastal engineering projects

#### *Land reclamation*

Land reclamation, or perhaps a better phrase, land formation, is the creation of new land at the edge of or in water bodies, usually along the coast. There are two different ways to reclaim land: dike construction and sand nourishment.

Shallow coastal areas can be reclaimed by building a dike which protects the new land from the sea. Excess rain and seepage water is drained and pumped out of the polder by a pumping station, so the land becomes suitable for urbanisation, industry, agriculture or other land uses. Sand and clay are the only materials needed for building the dike. The new land is what used to be the sea floor, and thus below sea level. Dikes have been used for centuries, mainly along the shores of the North Sea – in the UK, Germany and, famously, in the Netherlands.

Land reclamation can also be done with large amounts of sand, to create land above sea level. Examples of this can be found in South East Asia, notably China, Java, the Philippines and the Arabian Gulf, and are a recent phenomenon. These forms of land reclamation require very large volumes of sand, which is mostly obtained by capital dredging. Due to sand scarcity, the use of soft sediment for land reclamations is being explored and tested, e.g. in Manila Bay. Because of the use of fines, the latter likely have a higher carbon footprint than sand-based construction.

### **Port development**

Port development can be treated as a form of land reclamation, since, frequently, land is created in sea to accommodate port activities. However, this is a recent development, for example the second extension of the harbour of Rotterdam. Port development is also accompanied by the creation of navigation channels and port basins, both with a considerable impact on sedimentation. Another important element are harbour dams. Ports can be situated at the mouth of rivers, on sandy shorelines or adjacent to intertidal areas. These locations present very different challenges for maintenance dredging and sediment management.

Figure 3.1: Penang land reclamation (Source: Adobe Stock).



Figure 3.2: Port development in China (Source: Wikipedia)



Harbour entrance at IJmuiden (Source: Siebe Swart Fotografie)

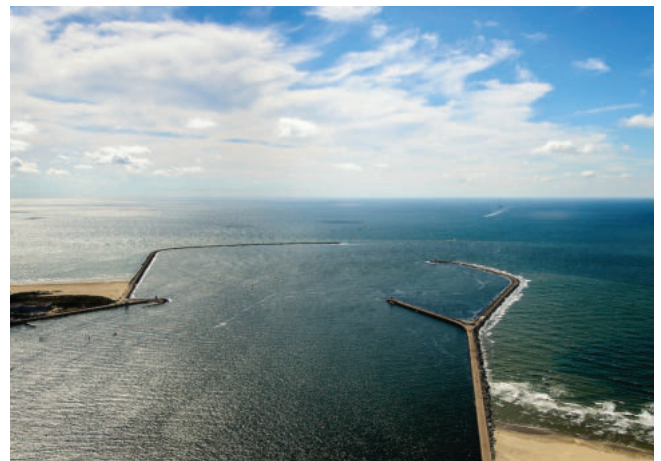

### Wetland restoration and creation

Although coastal development often leads to the reduction of coastal wetlands, recently, wetland restoration and creation has become a way to mitigate or compensate for any detrimental effects of engineering projects. There are also projects specifically aimed at restoring coastal wetlands and coastlines, such as in the state of Louisiana, USA, or compensating the loss of coastal wetlands because of coastal squeezing, as in the UK.

Natural wetlands are the product of slow evolution in a place with slow to moderate sedimentation rates. Hence, bulk density is often high, as is organic carbon content. New wetlands/habitats can be created in different ways, either through the direct placement of sediment from elsewhere (e.g. Marconi project and the Marker Wadden) or through the creation of conditions that promote fast sedimentation, for example behind wave breakers (e.g. Building with Nature Indonesia). Wetlands can also be restored through the restoration of connectivity with a sediment source that had been previously cut off.

Figure 3.3: Land reclamation for nature on Marker Wadden (source: Natuurmonumenten.nl), Fehmarnbelt (Source: New Civil Engineer), Marconi project near Delfzijl (source: ecoshape.org) and Building with Nature Indonesia (Source: Wetlands International)

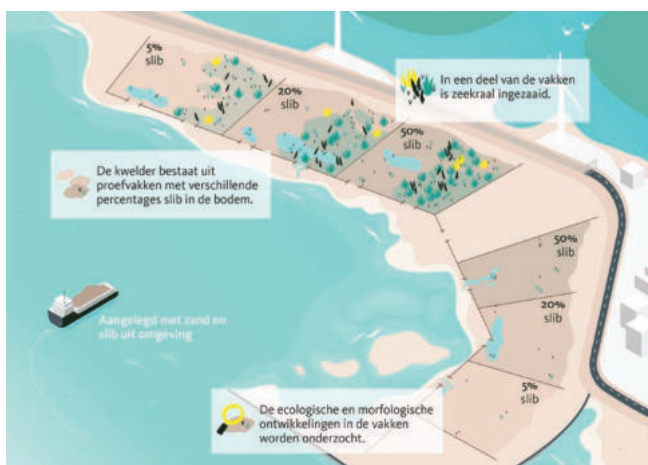

### **Coastal protection and management**

Coastal protection against floods is important, especially along lowland coasts, often uses dikes, and sometimes natural, and strengthened natural, dunes. Combinations of wide beaches and hard structures also exist, e.g. along the coast of the UK and Belgium. Combinations of dikes and coastal wetlands are found in both temperate and tropical regions. The use of hard structures, such as sea walls, groynes and breakwaters, in order to reduce erosion, is common practice and may have an impact on the sediment balance. Along sandy coasts, sand nourishment may be the main maintenance strategy.

## **3.3 Dredging**

### **3.3.1 General**

Dredging refers to abstraction of sediment from the sea bed, transport to its new location and application of the sediment on the project site. Many coastal engineering projects involve dredging activities. A distinction can be made between capital dredging and maintenance dredging.

#### **Capital dredging**

Capital dredging is the extraction of sediment from a sand pit, or excavation for new harbours and navigation channels. Capital dredging is a one-off activity. Capital dredging removes deep sediments, usually sand, which can be used for land reclamation, nourishing beaches, combatting coastal erosion and, for the appropriate types of sediment, also wetland creation. New land can be created with sand dredged from a deep sand extraction pit situated several kilometres from the coast. During the creation of new harbours and navigation channels, all sediment, including rock, sand or fine silts have to be removed from the project site.

#### **Maintenance dredging**

Maintenance dredging removes recently deposited sediments from navigation channels and port basins, to maintain the required depth. Maintenance dredging in harbour basins is a recurring activity, which often involves fine sediment, because fines settle easily in the calm waters of the harbour basin. The dredged material is often disposed in open water, or placed in

Figure 3.4: Beach nourishment in front of hard coastal defence structure near Zoutelande (Source: Zoutelande op de foto).



confinement when polluted. It can also be used for land reclamation and wetland creation. Maintenance dredging of water ways and port basins is considered separately from capital dredging, because it has different effects on the coastal carbon sequestration seascape.

#### **Dredging equipment**

A wide range of dredging equipment (see Figure 3.5) exists, with different impact on sediment and GHG emissions. The most commonly used form of dredging is hydraulic dredging, whereby sediment is loosened with a rotating cutter head, sucked into a pipeline and transported with large volumes of water to its destination, where the mixture of sediment and water is disposed. Pumping through a pipe requires high amounts energy, so a hopper is used for longer transport distances. A hopper is a dredging vessel that pumps sediment into its hold. At its destination, the hold is either opened, a method called 'bottom release', or the sediment is pumped, through a pipe, or directly, again with adding lots of water, in what is called 'rainbowing'. If the sediment source and its destination are close by, a cutter that pumps the sediment directly to its destination can be used. Direct emissions of CO<sub>2</sub> are large because dredging is energy-intensive. Greater the depth at the origin, further transport distance and a longer pipe all increase the energy requirements. Whenever possible, suitable material should be sought close by.

Figure 3.5: Some examples of dredging equipment



Cutter suction dredger with pipeline to the project area (Source: Van Loon Maritime Services).



Rainbowing (Source: Portsmouth City Council).

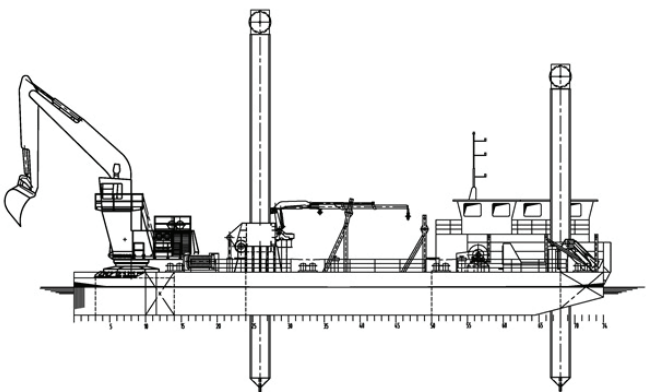

Backhoe dredger (Source: Van Loon Maritime Services).

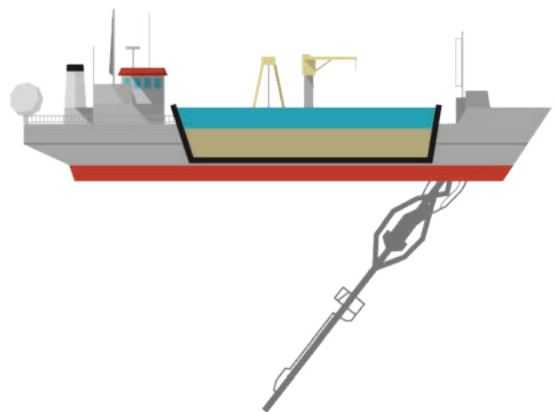

Hopper (Source: Studio Bolland, Behance.net).

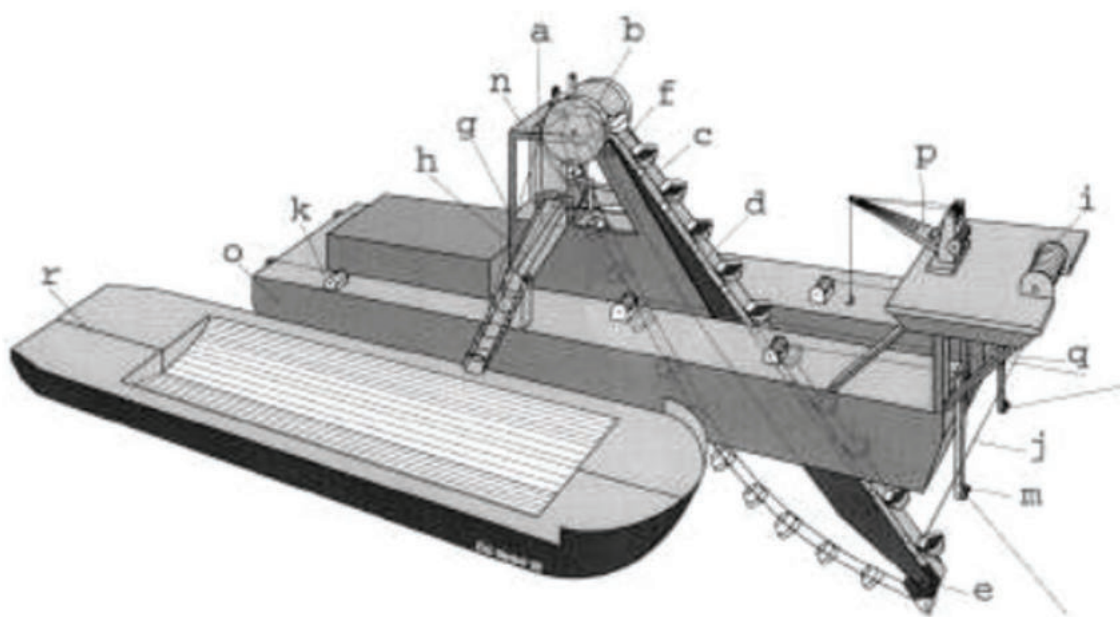

Simplified diagram of a barge loading bucket dredger (Source: Tuinhof 2014).



## Dredging plumes

When sediment is removed from the sea bed, particles are released into the water column and exposed to decomposition. This can be the result of direct disturbance of the sea bed, or overflow from the dredger itself. The overflow can cause a sediment plume, as in Figure 3.6, consisting of sediment particles, pore-water, organic matter, methane and nutrients. Plumes can result in:

- direct release of methane to the atmosphere, which depends on dredging depth;
- release of biologically available nutrients in pore water that can impact primary production, depending upon which nutrients are limiting locally;
- decay/mineralization of organic matter that is released in the plume, the amount depending on the percentage of reactive/labile organic matter and how the nutrients released upon decay may lead to further primary production and organic carbon sequestration;
- temporary covering of existing sediments. This can be detrimental to benthic communities and sequestration capacity of existing sediments, but on longer timescale, both will recover (see also placement in open water).

A smaller dredging plume may form where sediments are disposed and process water flows into the sea. With mechanical dredgers that do not pump sediment, such as bucket-ladder dredgers and backhoe dredgers, no water is added and the release of pore-water, fines, organic material and fines can be lower.

Where sediment plumes settle depends on hydrodynamic conditions and particle properties. The plume footprint (where it settles) can smother benthic communities. This also impacts the sequestration capacity of existing sediments, although this effect is usually temporary.

The maximum potential impact of dredging plumes is far less than that related to release from the matrix (see below) but may still be a substantial part of the direct CO<sub>2</sub> emission due to dredging.

The impact of dredging plumes can be mitigated by reducing overflow, usually at the cost of not using the full loading capacity of the dredging vessel. When

Figure 3.6: Dredging Plume consisting of fine sediment and organic matter (Source: Tuinhof 2014)



overflow is directed back into the pit by means of a fall pipe, a smaller dredging plume will form. The release of pore water cannot be limited but the release of fines and related organic matter can be reduced by reducing overflow. This may lead to a reduction of the carbon footprint where substantial amounts of labile organic matter are present with high reactive C/N and C/P ratios – often the case with more recent sediments with considerable input of terrestrial organic matter, e.g. in deltas.

### 3.3.2 Capital dredging

#### *Harbours and navigation channels*

Capital dredging typically exposes older sandy sediment layers, which are usually very low in organic matter largely consisting of recalcitrant forms. Consequently, the potential impact on carbon sequestration is limited.

There are, however, also sediments with higher organic matter content and a large proportion of labile organic matter, such as older peat layers. Dredging often exposes these peat layers oxygen-rich water, before trapped them in a matrix of sand and clay in a land reclamation project. Depending upon the reactive C/N and C/P ratios, mineralization of the labile component may lead to either outgassing of CO<sub>2</sub> or additional sequestration, due to nutrient driven primary production. Older sediments exposed by capital dredging and released in the sea can be seen as an

addition of carbon, fines and nutrients to the coastal system. Peat in other layers with a high organic matter content, always constitutes a large potential impact on the carbon footprint, so should be investigated carefully.

Sandy sediments, low in labile organic matter, may be used in different positions in a land reclamation of wetland restoration project.

Muddy sediments, with higher organic matter content and, frequently, higher percentages of labile organic matter, have a potentially large impact on the carbon footprint. This impact can be positive but is sometimes negative - this depends on the reactive C/N and C/P ratios of the sediment. If nutrient ratios are high, outgassing of CO<sub>2</sub> can occur when this organic matter is mineralized. Disposal in open, hydrologically and morphologically active environments, or in drained locations should be avoided because of exposure to oxygen.

At the time the second extension of the Port of Rotterdam was commissioned in 2008, it was contractually stipulated that sand could only be excavated from areas where the fine sediment content was less than 5%, in order to limit the development of dredging plumes during construction, thus limiting environmental effects. With the knowledge of today, it may have been possible to also limit the abstraction of sediments to those predicted to have a positive impact on the carbon footprint, ones with a low content of labile OM and high reactive C/N and C/P ratios. Similarly, it is now possible to stipulate that different sediments are used in different positions, if warranted by their different characteristics. Within some dredging areas, deep layers of clay and older peat are present, with very different characteristics. The old peat layer may have represented a large CO<sub>2</sub> emission potential.

### ***Sand pits***

The location of a sand extraction pit is mainly determined by the availability of sand of the right quality, distance from the project site and environmental considerations.

The creation of sand pits not only disturbs the sediment bed, but also results in the creation of a new depositional environments. In wave sheltered locations – behind breakwaters, in harbour basins, navigation channels and sand pits – large amounts of sediment can accumulate, often with high sedimentation rates. Where sedimentation is fast, there is little time for the transformation of organic material, and organic carbon is more or less sequestered. When sedimentation is slow, new depositional environments are more alike natural sedimentation environments and will show similar carbon sequestration.

In deep sand pits, flow velocities are low and fine sediments can settle. These settled sediments may be finer than the original sediments, and there may be anoxic bottom conditions, but this depends upon the location and shape of the pit.

Sand pits situated in dynamic coastal environments with high sediment transport rates will catch large amounts of (young) sediments. If these sediments are rich in labile organic carbon, fast sedimentation will limit decay and large amounts of organic carbon can be buried. The potential sedimentation rates of these pits exceed the sedimentation rate in coastal wetlands, meaning their potential to sequester carbon is much larger than that of coastal wetlands.

However, things are rarely that simple, as the carbon footprint comparison needs to be made between a situation with and without a sand pit. In the original location sediment may have been transported freely over the area destined to become a pit. This is linked

to the local sediment balance and, therefore, position of the existing coastline, depth of the sea floor and any accretion in coastal wetlands nearby. Because the surficial sediments may be constantly reworked by morphodynamics and sometimes bottom trawling, the organic carbon in these sediments may be part of an active dynamic equilibrium that keeps carbon and nutrients flowing, and contain low percentage of labile organic matter. Whether a new sand pit ultimately increases carbon sequestration depends on the properties of sediments and nutrients in the morphological development, and carbon cycle of the whole coastal system. A sand pit may be a net sink for carbon under the following conditions:

- The capture of sand and fine sediments does not lead to erosion and reduced vertical accretion in wetlands nearby. This is the case when the sediment budget is positive, the position of coastlines and wetlands is determined by hydrological conditions, and less so on sediment supply. When the volume of the pit is small compared to the overall sediment budget, its impact on sediment balance also tends to be small. Sand pits in deeper water further from the coast will not influence longshore transport and coastal dynamics as much;
- Fine sediments are captured in a carbon to fine sediment ratio equal or higher than in the surrounding coastal sediments. This ensures that fine sediments, a limited resource, are used in efficiently in the sequestration of carbon. Whether this is the case can be assessed by comparing the carbon to fine sediment ratio of surficial sediments with those of suspended fine sediments expected to be trapped in the pit;
- Carbon is sequestered in the pit in a C/N and C/P ratio equal to or higher than that in surrounding coastal sediments, i.e. the Redfield ratio. This occurs when particulate organic matter (POM) with higher ratios is captured as part of the process. Since POM with terrestrial origin has high C/N and C/P ratios, this is usually observed near river mouths. Higher C/N and C/P ratios in surficial sediments than deeper down are a good indication that rapid sedimentation will lead to higher sequestration.

Pits can be designed in a way that attracts either higher or lower amounts of fine sediments. Low gradient slopes and an orientation parallel to tidal currents will limit the settlement of fine sediments. The converse, steep gradients and an orientation perpendicular to tidal currents will promote sedimentation. In shallow coastal waters with considerable resuspension of fine bottom sediments, sand pits can be located in such a way that they trap density currents. Thus, sedimentation processes can be steered towards a more desirable carbon footprint. This requires sufficient information on the sediment characteristics, such as percentage of organic C and labile organic C and reactive C/N and C/P ratios, as well as the C/fines ratio of existing sediments and suspended matter, which illustrate the present situation and sediments expected to be buried in the pit. Furthermore, an assessment of sediment transport and balances should be made in order to ensure that enhanced sedimentation does not lead to a critical shortage of sediment elsewhere. Prediction of sedimentation rates in the pit is important because they determine the extent of aerobic decay of organic material.

Sand pits are a great opportunity for the long-term sequestration of carbon, since they are not vulnerable to storms or sea level rise.

### 3.3.3 Maintenance dredging of waterways and harbours

In navigable waters, maintenance work is frequent, either annually or almost continuously. This implies that most of the dredged sediment is recent, aerobic decay is substantial, but anaerobic decay may be limited. Sediment rates may be large, but frequent resuspension, due to shipping, also happens, so aerobic decay may be intense, with the exception of sediments that are buried in remote corners of harbour basins. However, little is known about the transformation of organic matter there and how it is affected by shipping and dredging activities.

Many harbour basins are situated in river mouths, so they may accumulate comparatively large amounts of terrestrial POM, which tends to be characterised

with high C/N and C/P ratios. Mineralization of those sediments usually results in outgassing of CO<sub>2</sub>, which is only temporarily delayed when trapped in harbour basins. Organic matter content in harbour basins can be very high, over 10%. For example, the Port of Rotterdam has very sandy sediments in the western part of the Eurogeul, while in the inner harbour basins, the fines and organic matter content is very high. OM content of the dredged material of Delfzijl harbour is also very high.

Crucial for assessing the impact of navigational dredging on the coastal carbon sequestration seascape is how these dredged sediments form part of a larger pool of sediments that is constantly moved by waves and tidal currents. From a long term perspective, these sediments are only temporary buried in navigation channels, so as long as there is no transformation of organic matter, navigational dredging can be neutral to the long-term carbon balance of the coastal system. Possibly, the impact of navigation dredging depends primarily on anaerobic transformation of organic matter, which takes place for the duration that these sediments are buried. Where duration influences this transformation such that it has consequences for carbon sequestration, altering dredging frequency, as part of the dredging strategy, may be an option that mitigates carbon emissions.

### ***Beneficial use of dredging sludge***

Maintenance dredging of harbour basins and navigation channels releases large amounts of sludge. This dredged material may need to be disposed back into the same morphological cell, in order to prevent coastal erosion, as is often done with sandy dredged materials along sandy coasts. Sand by-passing and back-passing, as well as disposal in nearby tidal channels, is therefore common practice. Beach nourishment with sandy dredged material is less common, since those sediments still contain a substantial fraction of fine sediments, which may affect the quality of public beaches. However, nourishment in the surf zone can largely avoid this problem, since most of the fine sediments will be taken away by wave action and longshore currents.

When the dredged materials are not needed to maintain the sediment balance, they can be used in

other ways, such as contributing to land reclamation works and wetland restoration and development. Use of dredging sludge may have additional benefits for the ecosystem-based carbon footprint of a project. Placement of dredging sludge in land reclamation and wetland restoration may reduce the return flow of fine sediments and thus reduce the need for maintenance dredging and related CO<sub>2</sub> emissions. Using dredged sludge in land reclamation will reduce the need for other building materials, which will further reduce the carbon footprint. Moreover, using it to create coastal wetlands, boosts their carbon sequestration capacity, reducing the project carbon footprint further still.

It has been possible to beneficially use dredging sludge for wetland restoration and creation without the need for coastal protection. Such examples suggest opportunities for avoiding carbon emissions, since the expected medium-term carbon sequestration in these wetlands surpasses the direct CO<sub>2</sub> emission arising from their construction. Additional ecosystem functions are even more prominent. Navigational dredging produces a constant supply of sediments that, with a more programmatic approach, can be used to restore and optimize coastlines with multiple benefits.

### **3.3.4 Sediment allocation**

The release location of dredged material is important for carbon emissions and sequestration. If the sediment is released in open water, such as a tidal channel nearby, the sediment, nutrient and carbon balance of the coastal system may not change significantly. However, sediments placed in confined spaces such as a land reclamation site, appreciably affect the carbon balance. Figure 3.7 summarizes the suitability of sediment for coastal engineering projects according to origin, key methods of allocation and relevance.

#### ***Sediment for beach nourishment or disposal in open water***

When used for coastal maintenance, such as beach nourishment, the sediment will be fully incorporated in the coastal system. Complete oxygenation can be expected and possibly also an increase in the availability of fines, when the fine sediment content is higher than that of the existing sediments.

### Sediment used for land reclamation

Sediments used for land reclamation are nearly always sandy and therefore contain limited content of TOC. Increasingly, the use of “unsuitables” is being explored in response to sand scarcity. This development may have an unwanted impact on carbon. Depending on the location of the reclamation with regard to tides, groundwater, and rainwater, there will be decay of organic material, and leaching towards the water body.

The greatest direct impact is related to aerobic decay and emission of carbon, leaching and outwelling of DOC, DIC and nutrients. The potential impact depends on whether new vegetation is established and the carbon sequestration potential prior to land reclamation. Sometimes, the major effects of the site relate to the substitution of an existing coastal habitat with a land habitat.

Figure 3.7: Origin of sediment, its allocation in the carbon seascape and application in coastal engineering projects

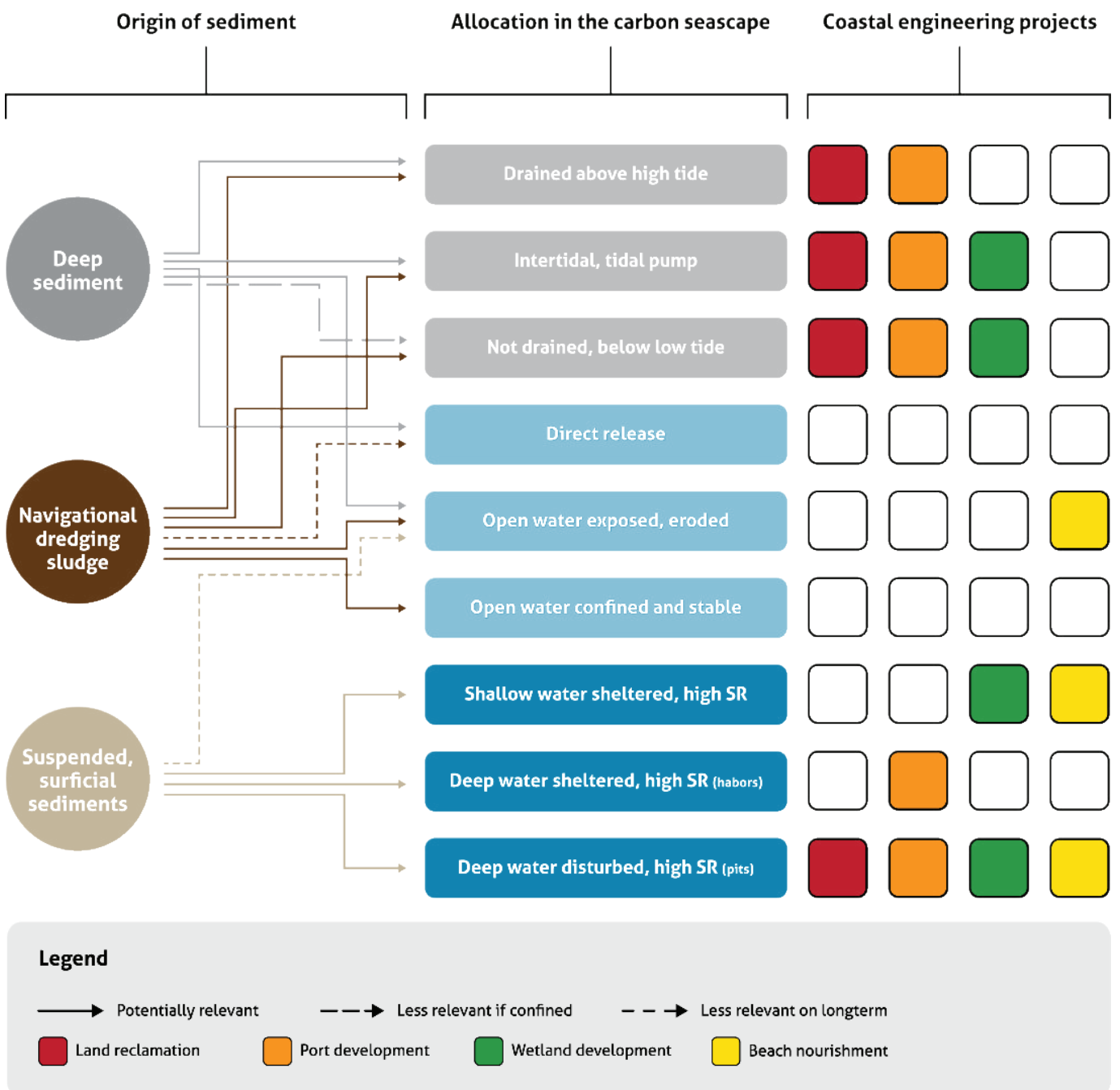

Importantly, when placed in a land reclamation or wetland restoration project, these sediments are subject to different conditions which will impact on the carbon footprint. Confined placement of sediments rich in organic matter with high reactive C/N and C/P ratios, for example sediments rich in terrestrial POC, will lead to increased carbon sequestration for the entire coastal ecosystem.

In recent years, interest in the use of soft sediments in land reclamation projects has grown, mainly due to the shortage of sand and availability of soft sediments, such as those obtained from navigation dredging. These sediments have varying contents of fines and organic matter and may comprise materials of different age. Older clay deposits can be rich in organic matter but the percentage of recalcitrant organic matter is usually high. Dredging sludge from waterways is organic-rich, with a high percentage of labile, reactive organic material. These soft sediments can have a major impact on carbon footprint. As discussed above, the potential impact depends on the content of labile organic matter and reactive C/N and C/P ratios and where the sediment is allocated within the land reclamation area - below low, above high water or within the intertidal zone. Furthermore, in semi-arid and arid climates there may be a tendency towards higher salinity - in such locations, an annual rainfall surplus may reduce salinity levels, with consequences for the retention of organic carbon.

In areas where sand is scarce, fine sediments could be used as a substrate for urban green areas, where geotechnical requirements are less stringent and the formation of a surface crust may be sufficient. In this way one could, in theory, enclose large amounts of OC rich fine sediments. However, whether this is a good idea will depend on the C/N and C/P ratio of these sediments, the sediment balance and the ecological

importance for establishing habitats and nourishing primary production, and the potential CH<sub>4</sub> formation and release. On the other hand, it may limit the direct CO<sub>2</sub> emission of the alternative, sand, if that would have had to be brought from far (Van Rijn, 2015)

### ***Sediment used for coastal wetland development***

Coastal wetlands can sequester large amounts of organic carbon in biomass and soils. This ability is based on a combination of high primary production, driven by import of nutrients, trapping of organic rich sediments, transformation of labile organic carbon into more recalcitrant forms, and the outflow and outwelling of a large share of their primary production as POM and DOM to nearby wetlands and coastal sediments where it can also be sequestered. A largely unexplored dimension, however, is that of inorganic carbon. Most wetlands are habitat to molluscs, crabs and other animals that form carbonate shells - a form of CO<sub>2</sub> sequestration. At the same time coastal wetlands can also reverse this process by dissolving carbonates that had been formed on site, or brought in from outside by rivers, tides and coastal processes.

Well known are the various ecosystem functions of coastal wetlands, such as food production, nursery for commercial fish species and role in coastal protection. Their ability to sequester carbon is an ecosystem function that can often be combined with other ecosystem services.

There are multiple benefits from blue carbon wetlands:

- coastal protection;
- steering flows and reducing undesired sedimentation for navigation,
- compensation and mitigation of environmental effects
- carbon sequestration.

Figure 3.8: Jubail mangrove park in Abu Dhabi, designed by GHD (Source: [www.ghd.com](http://www.ghd.com)).



Since some coastal wetlands are able to grow with sea level and sequester large amounts of carbon, their aesthetic potential should be considered, for example as an urban park in residential zones of land reclamation projects. Examples can be found in Hong Kong, Melbourne, Shenzhen and other coastal cities that value their mangroves as an urban asset. There are also examples that include salt marshes, such as the Marconi project in The Netherlands, which combines the creation of a salt marsh park with coastal protection.

There are several examples of mangroves and salt marshes that form part of new land reclamation schemes, or of existing wetlands incorporated into urban developments. Urban green areas can also be created by using fine sediments, managing their consolidation in such a way that the load-carrying capacity of its crust is sufficient for establishing vegetation.

Coastal wetlands can contribute to coastal protection. Although they do not grow above high water levels, they can work in combination with dikes, trapping sediment, creating foreshores that attenuate waves, act as buffer for coastal erosion during extreme storm events. Wetland vegetation is key for its capacity to attenuate waves, a consequence of not only the plants' ability to absorb some of the wave energy, but also the shallow foreland formed around them.

Figure 3.9: Newly created salt marshes that form part of project Marconi near Delfzijl, the Netherlands (Source: EcoShape).



The hybrid combination, wetland with a dike, can:

- Safeguard and maintain existing coastal wetlands, when their wave reducing capacity is sufficient to prevent the need for further strengthening of an existing dike.
- Restore and maintain degraded coastal wetlands, achieved by wave sheltering and active sediment nourishment, so that their wave reducing effects limit the need for further strengthening of existing dikes, or would make strengthening substantially cheaper.
- Increase the wave reduction capacity of an existing coastal wetland, by creating conditions for autonomous enlargement and vertical development. An example of this is the project Koehaol, which uses the strategic placement of dredged sediment from the harbour of Harlingen to stimulate horizontal and vertical growth of existing salt marshes. In some cases, the area near the dike can be elevated above high tide levels, in order to achieve higher safety standards, so the coastal wetland itself becomes a hybrid.
- Create new coastal wetlands and forelands, where these are largely absent. Their absence is an indication that hydrological conditions and/or sediment balance are not favourable, so a combination of encouraging suitable hydrological conditions and/or providing sediments is appropriate. An example of this is project Marconi, in which new salt marshes were created as part of a coastal defence.

All of these options can be used in coastal protection schemes. Mangrove belts are specifically protected in countries like Vietnam because they are vital for wave reduction, in combination with a dike. In areas such as the Mekong Delta, most dikes are made from local materials, mainly clay. These dikes cannot withstand larger waves, but the additional sheltering by a mangrove belt enables them to do so, and thus provide a cost-effective form of coastal protection. At the moment, various models are available to predict the wave attenuation capacity of mangroves. Similarly, salt marshes are also used for coastal protection in countries such as Germany. In the Netherlands, a research programme looked more closely into the wave attenuating capacity of salt marsh, with special

emphasis on the role of salt marsh vegetation and the stability of soft foreshores against major storms. This will help to formalize the true potential of salt marshes as wave attenuators in coastal protection schemes.

Strengthening dikes, especially those that need to withstand larger wave height, is very costly, but combinations with foreshores and coastal wetlands can improve cost-effectiveness, mainly in areas where conditions for coastal wetlands are favourable. As discussed above, the carbon sequestration capacity of coastal wetlands is large enough to offset the direct CO<sub>2</sub> emissions related to their restoration and creation. In addition, if they can prevent or limit the need for strengthening, a large reduction in direct CO<sub>2</sub>

Figure 3.10: Map showing the Ecoshape project Koehoal (from: Project 'Kwelderontwikkeling Koehoal' - It Fryske Gea)

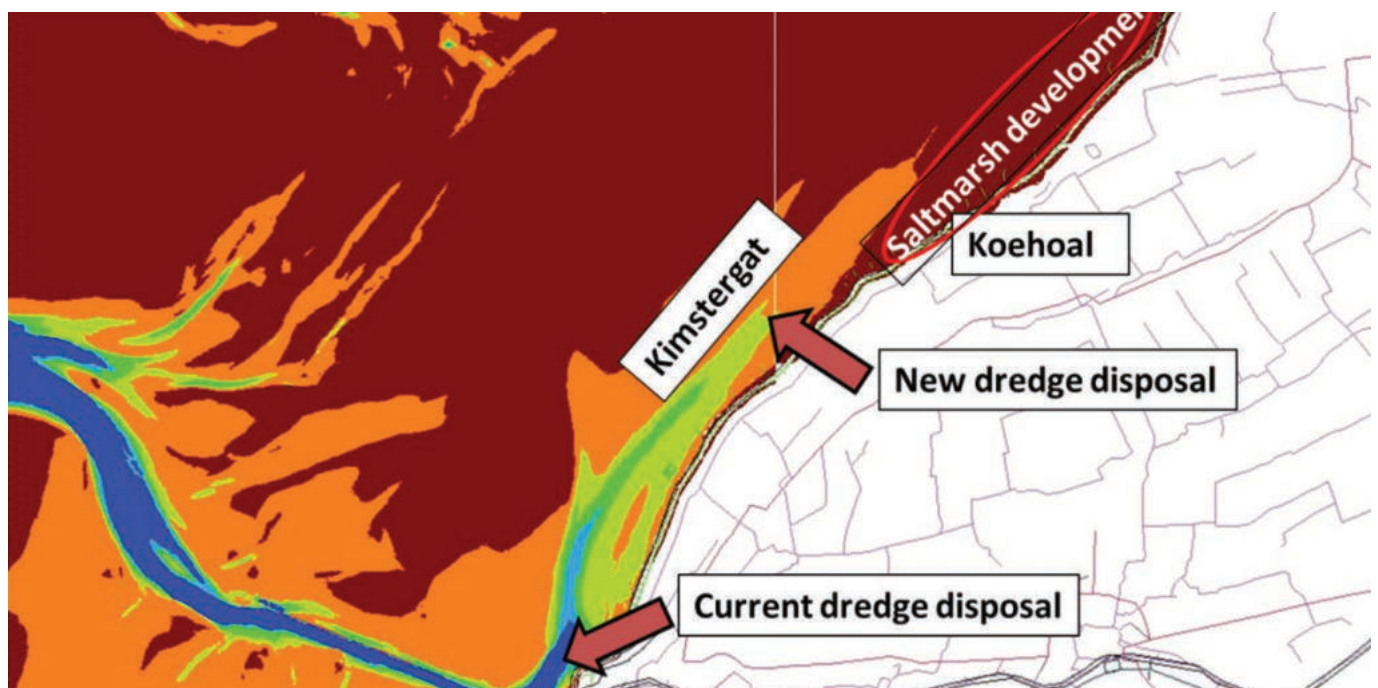



emissions from materials and machinery will contribute to an even lower carbon footprint overall.

Creating wetlands contributes to mitigating carbon emissions in two different ways: the wetlands themselves are able to sequester carbon at rates of 1 to 3 ton organic carbon/ha/year, which, over the lifetime of the project, easily offsets the CO<sub>2</sub> emissions of their construction. Secondly, because coastal wetlands attenuate waves, dikes need less strengthening, if at all. Strengthening existing dikes with stone revetments can involve large CO<sub>2</sub> emissions, because the work involves large scale use of machinery and also building materials. In areas such as Vietnam, mangrove belts are used in such a way that the wave energy at the

dike is limited so it can be built with local clay. This greatly reduces the carbon footprint of coastal protection, compared to the alternative of using concrete revetments.

The restoration and creation of coastal wetlands may lead to additional sequestration of organic carbon. The CO<sub>2</sub> emissions related to wetland creation, especially on less suitable areas, is substantial, but are in the long run mostly offset or surpassed by the additional carbon sequestration that is achieved. Since most wetland creation projects can be seen as a transformation from one type of carbon sequestration potential to another, the comparison of both will show the total effect.

**Table 3.1: Blue carbon wetland creation: emitted and avoided CO<sub>2</sub>, carbon sequestration**

Type	CO <sub>2</sub> emissions	Carbon sequestration potential	CO <sub>2</sub> emission avoided
Screens/poles promoting sedimentation	Small, especially when local materials are used	Large, when these lead to higher sedimentation rates and wetland restoration	Large, when major dike strengthening projects can be avoided, or if dikes can be built using local materials, with a smaller CO <sub>2</sub> footprint
Breakwaters creating wave shelters	Moderate to large, depending on the design	Also large, as above	As above
Nourishment intended to maintain coastal wetlands	Moderate to large, but smaller if nautical dredging sludge can be used nearby	Also large, when nourishment simultaneously safeguards or furthers existing wetland development	As above
Building and protecting new salt marshes	Large, depending on the volumes of material needed, and off-site effects		

Table 3.2: Summary of carbon flux in marine and coastal habitats (Source: Gregg et al., 2021)

Habitat Description	Annual Carbon burial rate/loss for the habitat			References
	CO <sub>2</sub> e ha <sup>-1</sup> y <sup>-1</sup>	Range (if possible)	Confidence (High, Medium, Low)	
<b>Sand dune</b>	-2.18	-2.13 to 2.68	Low	Jones et al. (2008); measurements were made in Anglesey, Wales. No data available for England.
<b>Salt marsh</b>	-5.19	-2.35 to -8.03	Low	Beaumont et al. (2014); based on previous assessments by Cannell and other (1999); Chmura et al. (2003) and Adams et al. (2012); Estimates are for the whole of the UK.
<b>Intertidal sediments</b>	-1.98 <sup>ab</sup>	-0.40 <sup>a</sup> to -3.45 <sup>b</sup>	Low	Armstrong et al. (2020); estimated values for Wales. Adams et al. (2012); measured values for the Ouse estuary, England.
<b>Subtidal sediment</b>	-1.12 <sup>ab</sup>	-0.07 <sup>a</sup> to -2.16 <sup>a</sup>	Low	Queiróset al. (2019); measured values from the English Channel. De Haas et al. (1997); estimated value for the North Sea.

### 3.4 Hydraulic structures

#### *New depositional environments*

Coastal structures such as breakwaters, harbour dams, navigation channels and harbour basins create new areas where sediment can be deposited. Navigation channels can be positioned in very different locations with respect to longshore transport and tidal currents, which will determine the texture and organic matter content of the accumulated sediments. Navigation

channels and harbour basins also face frequent resuspension due to shipping, so oxygen supply to these sediments is high where shipping creates turbulence. A major difference from sand pits is that navigation channels and most harbour basins are maintained by dredging, so the sediments never become old enough to allow complete anoxic decay.

### ***Hydraulic structures which reduce tides and inundation***

Structures such as storm surge barriers may reduce the tidal amplitude, which reduces inundation in the higher part of the intertidal zone. With the absence of inundation, soil conditions change - in arid climates salinity will increase, in wet climates salinity will decrease, all with consequences for the stability and decay of organic matter. Notably, lowering the salinity level below 15 ppm can induce methane formation, partly because the influx of sulphate is greatly reduced.

Soils that are no longer inundated are also no longer fed by organic matter and nutrients. This reduces primary production, while the absence of tides also increases drainage and aerobic decomposition. Overall, soil organic matter will decline.

With less tidal activity, the scale of the tidal pump is also reduced. Lateral fluxes of DOC, DIC and POM, as well as the dissolution of PIC as a result of the anaerobic decay of organic matter is reduced.

Where drainage reduces due to the absence of tides, and decrease in water exchange, can thus induce anaerobic conditions, causing root decay in plants adjusted to better drained soils in the intertidal zone, and the decay of those roots can lead to methane emission.

In summary, limiting tides will, in most situations, lead to a reduction in carbon stocks and carbon sequestration capacity for organic carbon, the emission of methane may increase, especially in microtidal, waterlogged conditions.

### ***Carbon sequestration behind hydraulic structures***

The "carbon sequestration logic" for wave sheltered environments is very similar to that for a sand pit. Again, position and design affect sedimentation. However, sandpits are usually situated in deeper water, while hydraulic structures – in shallow water, mostly in the intertidal zone and connect to the shore. These structures directly influence coastal processes and longshore currents, where sediment transport is intense with also a higher component of coarser

fractions. Sedimentation will eventually raise the sea floor, which, in turn, enables the establishment of coastal wetlands, contributes to carbon sequestration. In conclusion, the design can be geared towards the stimulation of coastal wetland development or be explicitly used for the restoration of coastal wetlands. The sedimentation caused by hydraulic structures can also develop a wave attenuating foreland as part of a long term coastal defence strategy.

Most hydraulic structures disturb ongoing longshore processes, and it may take many years before shorelines reach a new equilibrium. Preferably hydraulic structures should be placed in line with the anticipated long term equilibrium, in order to limit the need for maintenance.

There are many types of hydraulic structures with different functions and potential to alter sedimentation. Harbour dams can be designed with an orientation that facilitates nautical access and/or limits sedimentation and the need for nautical dredging. In contrast, other harbour dams with deeper navigation channels usually block longshore transport of sediments, resulting in an active sedimentation up-current and potential erosion down-current, and are sometimes combined with by-passing or even active back-passing schemes.

Breakwaters are often built in order to prevent coastal erosion or to facilitate sedimentation. On sandy shorelines, they are often designed in a way to limit wave energy on the shoreline and prevent rip currents that transport sediment towards the sea. They safeguard and support, or will reach a dynamic equilibrium, where no net sedimentation is observed. On muddy coasts, breakwaters can be used not only to reduce wave energy and promote sedimentation, but also to restore or create conditions that enable coastal wetland development. These breakwaters are designed in a way that promotes sedimentation.

The sedimentation rate is critical for mineralization of organic matter. However, with sedimentation rates above 1 cm/y, the mineralization of organic material is limited and carbon to phosphorus and carbon to nitrogen ratios are usually in line with the Redfield ratio. They may be higher when sediments are trapped with

a proportionally large terrestrial POM component that usually has higher C/N and C/P ratios - this typically occurs near river deltas. There are indications that sedimentation rates lower than 1 cm/y would result in higher C/P ratios, but in most wave sheltered areas, sedimentation rates are higher than that. Sedimentation is also much higher than in natural coastal wetlands, and gross carbon sequestration rates may be 4-10 tons/ha/year until the wave sheltered area reaches a new equilibrium.

The robustness of the hydraulic structures determines whether sedimentation leads to long term sequestration. Most harbour dams have technical lifetimes of several decades, but the need for a harbour dam may continue much longer. Breakwaters may have shorter technical lifetimes and some wooden structures tend to only last a few years. However, not the technical lifetime, but the need to maintain structures, will determine whether sequestration is long-lived, as well.

### 3.5 Conclusions

Most coastal engineering projects influence the carbon balance by re-distributing sediments, changing hydrological conditions that influence sedimentation and water exchange in soils. In addition, the creation of sand pits, ports and land reclamation areas, transforms coastal sediments and wetlands into urban areas and industrial zones, which have a lower carbon sequestration capacity. So the focus for initial assessments should be on these processes. However, the effects largely depend on the type of sediment that is moved and particularly the percentage of labile organic matter and its related C/N and C/P ratios. This information is critical in estimating the carbon footprint. Significant impacts should be anticipated where sediment rich in organic matter and PIC is placed in positions that favour anaerobic decay of organic matter, which will produce acids that lead to the dissolution of PIC.

The way sediments are handled is decisive for the ecosystem-based carbon footprint of an engineering project. Table 3.3 gives an overview of the engineering options available to steer sediment handling towards a lower carbon footprint. This may require preventing or promoting sedimentation, since the ef-

fects are very different for different types of sediment and are largely dependent upon the reactive C/N and C/P ratios.

All things considered, sediments rich in organic material are best placed below the aerobic zone, while sediments poor in organic matter - high in the profile. Sediments rich in carbonate are best placed in the intermediate zone.

In summary, a coastal engineer has quite some options to design and execute a coastal engineering project more carbon-friendly, see Table 3.2. for more detail:

- More carbon-benign handling of sediments during dredging, for example by optimizing dredging plumes, using the sequestration potential of sand pits, by adopting different approaches to the dredging of waterways and harbours, and for land reclamation.
- Beneficial use of dredging sludge; for instance for wetland creation and restoration, or land reclamation.
- Creating beneficial hydrological conditions, such as environments sheltered from waves, where higher sedimentation rates lead to coastal wetland development and its associated carbon sequestration.
- Careful release of dredged materials into the seascape, according to sediment characteristics (rich or poor in organic matter, fine sediments, or rich in carbonate), for example when used for beach nourishment, land reclamation, or coastal wetland development.
- Steering currents and reducing undesired sedimentation in navigation channels, and the compensation and mitigation of environmental effects.
- Adopting the Building with Nature approach and integrate nature in the design, implementation and maintenance of the coastal engineering project.
- Protection, restoration and creation of coastal wetlands, such as mangroves and salt marshes, because of their potential to store carbon. These can sequester 'blue carbon' in vast quantities, exceeding emissions from coastal infrastructure development.

Table 3.3: General overview of options available for sediment handling to reduce the ecosystem-based carbon footprint

Engineering activity	Options to reduce carbon footprint	Remarks
<b>Capital dredging for land reclamation</b>		
<b>Dredging plume abstraction site</b>	Reduce/increase overflow of fines and associated OM. Using a fall pipe reduces the formation of a sediment plume.	Release of pore water cannot be limited with hydraulic dredging. The impact on the carbon footprint can be substantial, especially of muddy sediments.
<b>Dredging plume building site</b>	Reduction/increase of flushing of fine sediments and OM is possible for example using temporary dams, sequencing of work so sediments rich in fines are delivered in more confined spaces etc.	Some reduction of flushing is possible.
<b>Sand pit/burrow</b>	Orientation, depth and shape influence sedimentation of fines and sedimentation rate.	Possibilities to change location are often limited because of licensing, but depth and shape can be controlled.
<b>Dredged materials</b>	Depending on stratigraphy specific sediments, e.g. peat and clay layers, can be avoided or timed so that they can be ideally positioned.	Note that because of environmental effects, sediments with higher fine content are already being avoided.
<b>Sediment positioning/placement</b>	Depending upon sediment characteristics, there may be a preferential position, high or low or confined in the profile.	The use of sediments rich in organic matter and fines is somewhat restricted to urban green areas.
<b>Maintenance dredging</b>		
<b>Dredging plume</b>	See above	Effects are more neutral, since most navigation dredging is primary recycling of recent sediments
<b>Disposal site</b>	A disposal site can be chosen in such a way that wetland restoration is enhanced, or in more wave sheltered areas if confinement is preferred.	Disposal within the same morphological cell may be necessary in order to maintain the sediment balance and prevent coastal erosion.
<b>Dredging frequency and strategy</b>	Anaerobic processes can be either favoured or avoided, so the dredging strategy should aim to influence the frequency of dredging, e.g. by using sediment pits/traps.	There may be environmental constraints that limit operations to specific times of the year, e.g. outside the growing season to ecological impacts are limited.
<b>Sand/beach nourishment</b>		
<b>Dredging plume</b>	See above	
<b>Sand pit/burrow</b>	See above	
<b>Dredged materials</b>	See above. Depending on the location by-passing, or using sediments generated by nautical dredging may be preferred.	For coastal protection and maintenance there often is a preference for less erodible coarser sands, which usually are also low in fine sediment content.
<b>Sediment placement</b>	The nourishment of sand can be done on the beach, in the breaker zone or close to the shore as a feeder berm.	Regardless of the its placement, erosion of most sediments is unavoidable.
<b>Nourishment frequency</b>	Beach nourishment can be done annually, periodically or incidentally, using larger volumes in the form of a feeder berm or sand motor.	

## Chapter 4

# Estimating the ecosystem-based carbon footprint of coastal engineering

### 4.1 Introduction

Every hydraulic engineering project causes CO<sub>2</sub> emissions – both directly, by using heavy machinery, and indirectly, embodied into the materials used. Production of some materials emits large quantities of GHG, e.g. concrete, steel, iron, and transport always causes emissions. For the purpose of calculating the carbon footprint of engineering projects, focus is typically on direct CO<sub>2</sub> emissions; for most construction on land, this tends to be sufficient. However, for coastal engineering projects, the situation is different. Direct CO<sub>2</sub> emissions are still important, but the impact of coastal engineering interventions on the carbon stocks and carbon sequestration capacity of coastal ecosystems may be much more important. Most coastal sediments contain trapped organic carbon, which can potentially cause more emissions per m<sup>3</sup> of sediment than the direct emissions from abstracting, transporting and disposing it over 10 km away. In this chapter, we focus on how the ecosystem-based carbon footprint of coastal engineering projects can be calculated and what information is needed to carry out such an analysis.

### 4.2 General assessment scheme

The ecosystem-based carbon footprint of a project is the difference between emissions from an undisturbed coastal zone (business-as-usual scenario, BAU) and the emissions arising from the coastal engineering project. Evaluation comprises four steps (Figure 4.1), which may run parallel to an ongoing Environmental Impact Assessment (EIA) study:

1. A description of the carbon seascape where the project takes place;
2. A description of the coastal engineering project (the project alternative) and the business-as-usual scenario in terms that are relevant for the ecosystem-based carbon footprint;
3. Assessment of potential and relevant effects;
4. Calculating the ecosystem-based carbon footprint.

#### 4.2.1 Step 1. Describing the (current and future) carbon seascape

##### 1a. Current carbon seascape

The first step is to describe the current carbon seascape, as far as preliminary data allow, and to assess relevant trends that may influence the development of carbon stocks and carbon sequestration in the future. As outlined above, an inventory of processes and incidents, such as major storms that may influence the long-term sequestered carbon, is needed. Figure 4.2 summarises the most important variables that should be included in the description of the carbon seascape.

Figure 4.1: General assessment scheme of the ecosystem-based carbon footprint of a coastal engineering project.

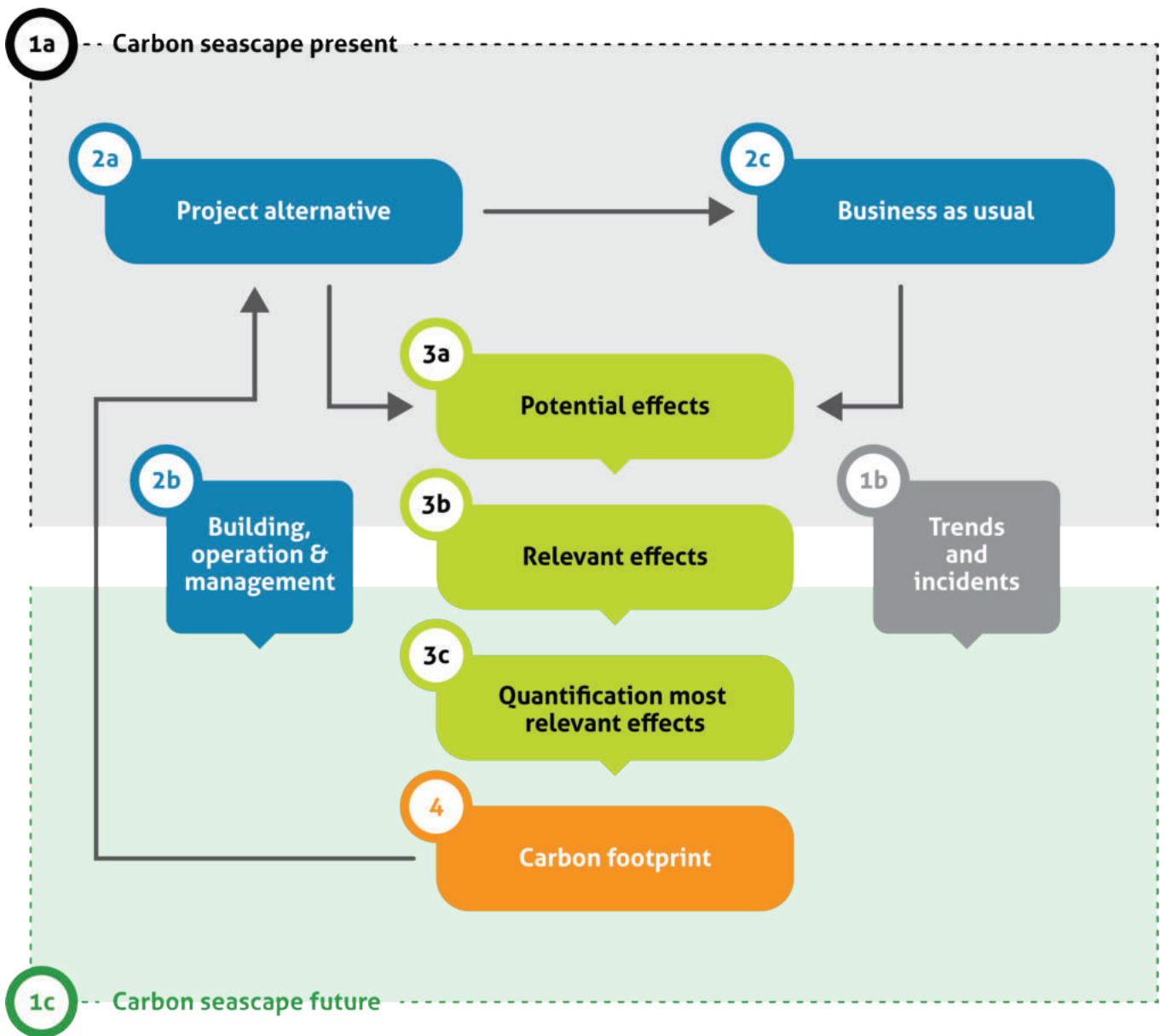
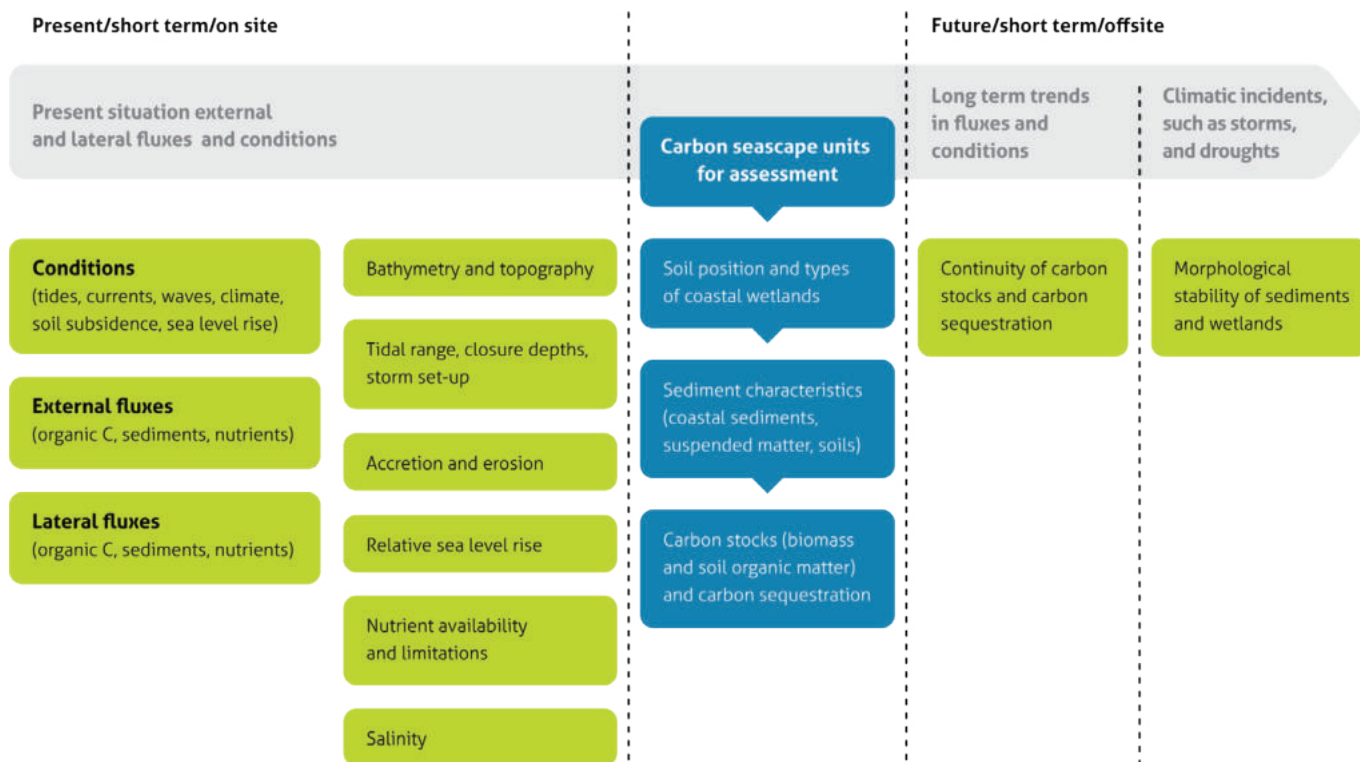

Figure 4.2: Variables that influence changes in the carbon seascape over time



### Stocks and Fluxes

As discussed in chapter 2, a good understanding of stocks and fluxes of carbon is needed. We need to focus on those elements of the seascape where impacts on sediments and soils are to be expected, since that is where carbon stocks and fluxes are most likely to change. This yields a number of potential variables that require an initial assessment in order to know whether they are relevant enough for the ecosystem-based carbon footprint and merit further analysis.

### Characterisation of soil and sediment position

The carbon seascape comprises soils and sediment in very different conditions: shallow coastal areas in the intertidal and subtidal zones, continental shelf, open ocean. Each has its own set of sedimentation rates, resuspension rates, bioturbation, drainage and other factors that determine the production, burial, decay

and final sequestration of organic carbon. It is characterized by the following parameters:

- bathymetric and topographic information;
- tidal range, relevant closure depths for frequent and less frequent storm events, storm set-up levels;
- observed coastal accretion or erosion (which give important indications for sediment budgets);
- relative sea level rise, i.e. the combination of sea level rise and land subsidence, which is a critical parameter for sediment budgets, sedimentation rates and sequestration rates;
- nutrient availability in coastal waters, which gives information on whether primary production is limited by nitrogen, phosphorus or, possibly, iron;
- salinity and its seasonal variability.

When sediment models are available, resuspension and sedimentation rates can be added.



### **Characterisation of soils and sediments**

A thorough description of the types of sediments that will be moved, used, deposited, trapped or that will undergo major changes due to the project, is essential. Information is needed regarding the organic carbon present in soils and sediments, the percentage of labile organic matter that may decay because of sediment handling or be trapped, and the carbon-to-nitrogen and carbon-to-phosphorus ratios of this organic matter. Better yet is to inventory the reactive C/N and C/P ratios, which include all biologically available phosphorus that may be released. As discussed, these ratios determine the potential renewed primary production that may compensate for the direct loss of carbon due to decay.

From proxies to quantification using field data  
Initially, if local data are scarce, one may have to rely on proxies and general figures, but only under the condition that the local carbon seascape does not present a unique assembly of conditions. In the case of capital dredging, basic data regarding sediments to be excavated need to be available. Since an inventory of sediments will be needed regardless, in order to determine geotechnical parameters, additional sampling and analyses incur few additional costs.

#### **1b. Relevant trends and conditions**

Since the ecosystem-based carbon footprint is intended to be medium- to long-term, it needs to take into account potential trends in important factors that may influence organic carbon production and sequestration. Over time, extreme events, such as major storms, may determine the long-term stability of coastal sediments and wetlands. Various trends may alter the conditions that determine carbon sequestration, such as (relative) sea level rise, fluvial sediment inputs, local sediment inputs dependent upon long-shore transport, nutrient influx from nearby rivers and possibly urban areas. Current data, such as carbon stocks and surficial sediment characteristics, should be interpreted within this context.

#### **1c. Future carbon seascape**

Assessment may show that the present and future carbon seascapes are very different and that present-day sequestration rates and effects cannot be easily

extrapolated over longer time periods. When this is the case, assessment should focus on the longevity of carbon stocks and examine the trends that influence carbon sequestration, and morphological stability of sediments and wetlands vis-a-vis major storms.

### **4.2.2 Step 2: Description of the coastal engineering project**

#### **2a. Project alternative**

The second step is to give a description of the interventions and activities the coastal engineering project consists of, and how it impacts the carbon seascape:

- Sediment: dredging activities, volume and type of sediment to be moved or deposited;
- Structures: hydraulic structures, such as dams and dikes, and their potential impact on sediment transport and sedimentation, hydrology, tidal regime, etc.;
- Conversions: replacement of existing habitats with new environments, such as land reclamation, harbour basins, navigation channels, sand pits etc.
- Maintenance: activities post-completion that may impact the carbon seascape;
- System-effect boundaries, identification and description of relevant system boundaries for local and remote, short-term and long-term effects.

As we have seen, most impacts on the carbon stocks and flows are related to the handling of sediments and the impact of hydraulic structures. For the evaluation of sediment handling, one needs to know the volumes excavated and transported, the methods of excavation, transport and disposal, and use that information to anticipate the potential decay of organic matter and subsequent emissions. When sediments are used in land reclamation, the position of these sediments with respect to drainage conditions and tides needs to be known. When sediments are disposed, one needs to know the hydrodynamic conditions of the disposal location, which may eventually lead to resuspension. For a satisfactory impact assessment of a sediment pit, one needs to be able to predict to what extent it will trap (fine) sediments. Most analyses require that a detailed characterisation of the source and new position of sediment is available.

## 2b. Building, operation and management

It is important to forecast carbon sequestration and emissions over the entire life span of the project. This includes the construction phase, as well as operation and management phase.

## 2c. Business-as-usual scenario

A comparison needs to be made between the situation with and without the project. In order to make this comparison, the business-as-usual scenario, without the project, should be described within the same system-effect boundaries that apply to the engineering project.

### 4.2.3 Step 3. The assessment of effects

#### 3a. Potential effects

Figure 4.3 gives an overview of potential effects related to coastal engineering projects. It is a long list, but most effects relate to sediment handling and rely on information concerning labile organic matter within sediment that is excavated, transported, disposed or

trapped. Note that some effects may not be relevant in low-carbon environments, where sediment is mainly sand with very low labile organic carbon content.

The following processes are potentially relevant to the carbon balance of the coastal carbon sequestration landscape:

#### A. The handling of sediments, dredging, disposal and positioning of sediments leading to three different effect chains:

- The direct release of nutrients from pore water due to dredging, notably phosphorus and NH<sub>4</sub>;
- The direct release of labile (organic) carbon, nutrients and fines due to dredging, from the sediment matrix into dredging plumes, at both the excavation site and project site;
- The indirect release of nutrients, DOC, DIC and TA after construction due of aerobic and anaerobic processes in the sediment in its new location/position.

Figure 4.3: Potential effects of coastal engineering projects

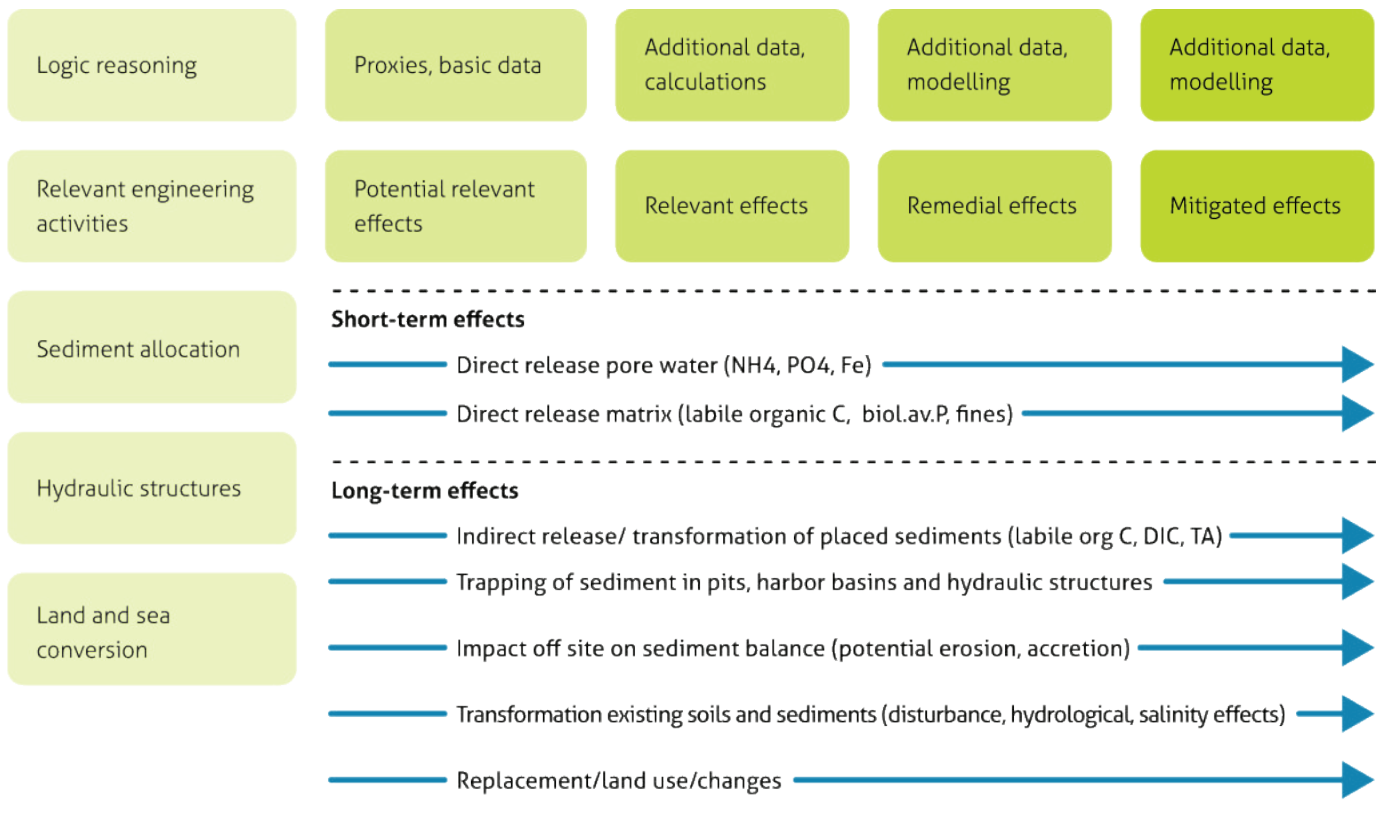

## **B. The trapping of sediments in pits and behind hydraulic structures:**

- The sedimentation in sand pits and burrows, in a confined, undisturbed environment in deeper water;
- The sedimentation in navigation channels and harbour basins in confined, but frequently disturbed environments, due to shipping and maintenance dredging;
- The sedimentation behind breakwaters and dams, usually confined and undisturbed, until it reaches a morphological dynamic equilibrium or a development into a coastal wetland.

## **C. The erosion of sediments and soils due to changes in sediment balance/budgets:**

- Erosion and disturbance of surficial coastal sediments, leading to aerobic decay of organic matter and release of nutrients;
- Erosion of coastal wetlands, leading to lateral fluxes of (fine) sediment, organic carbon and nutrients.

## **D. Transformation of organic matter in existing soils after construction, because of hydrological conditions:**

- Increased drainage and related emissions through aerobic decay, mostly of anaerobic soil layers;
- Decreased drainage and waterlogging, and decrease in aerobic decay, also with potential formation of methane;
- A reduction in tidal dynamics, meaning less infiltration and input, and less outwelling, which may change the overall carbon balance, as related to organic and inorganic carbon, as well as changes in salinity and drainage conditions.

## **E. Replacement of land forms/uses.**

- Replacement of coastal sediments with a sand pit, harbour basin, navigation channel, or even coastal wetland, so the net change in carbon sequestration is sequestration in the previous minus the new situation.

## **F. Creation of ecosystems**

- Increased sequestration e.g. through adopting the Building with Nature approach that integrates nature in the design, implementation and maintenance of the coastal engineering project.
- Protection, restoration and creation of coastal wetlands, such as mangroves and salt marshes, because of their potential to store carbon.

The description of potential effects should preferably use field data, especially considering relevant sediment characteristics.

### **3b. Focus on the most relevant effects**

Not all effects on the carbon seascape may be relevant, either because they are small, or because they take place in a low-carbon environment, or represent only temporary effects that are less significant on the longer term. Effects can also be small when compared to the direct CO<sub>2</sub> emissions of a project. Most relevant are the effects with a major impact on the ecosystem-based carbon footprint and for which there are emission reduction options available (see chapter 2).

A distinction can be made between the short-term effects of direct release of organic carbon, nutrients and fines, and long-term effects, such as the build-up of sediment in pits or behind hydraulic structures. Long-term forecasts need to take into account trends in sea level rise and sediment input, possible consequences for sediment balances, and an assessment of the morphological stability of wetlands and sediments (see also chapter 3).

Evaluation of the trends in nutrient inputs, particularly those from rivers, may indicate future changes in sequestration rates, e.g. because of land use change or better wastewater treatment. In addition, possible changes in storm incidence will help calculate closure depth, and also determine the long-term stability of coastal sediments and wetlands.

### 3c. Quantification of most relevant effects

A comprehensive assessment is time-consuming and requires vast amounts of data. A pragmatic approach would be to use proxy data for an initial assessment, and decide whether certain effects merit further analysis and data gathering. As indicated, one would expect that additional analyses of labile carbon, phosphorus and C/N and C/P ratios could easily be added to the geotechnical analyses of deeper sediments that result from capital dredging. Similarly, in the case of maintenance dredging, sediments often have to be sampled and analysed for pollutants. In this case, additional analysis of parameters that are relevant for ecosystem-based carbon footprinting, could easily be added. The most important effects may also need to be underpinned by modelling.

From released nutrients to renewed primary production and renewed carbon sequestration

What many effects have in common is the direct release of nutrients and indirect release of nutrients after decay of organic matter. For ecosystem-based carbon footprint calculation, it is important to know how these released nutrients may lead to renewed primary production and carbon sequestration, thus compensating for the loss of labile organic matter. Released nutrients may increase primary production in coastal waters and ocean in the form of algae, where C/N and C/P ratios are close to the Redfield ratios. Nutrients may also become available for primary production in nearby coastal wetlands, increasing plant biomass in the form of leaves, stems and roots, where C/N and C/P ratios higher than Redfield reference values. However, in both situations, most of the organic carbon captured this way will soon decay and be re-released as carbon dioxide and nutrients. One needs to know what part of the released nutrients will lead to (additional) primary production, which may be close to 100% in coastal systems with strong nutrient-limited primary production potential. Only a small part of the organic matter formed in ocean waters is eventually buried in marine sediments; a larger part may be biomass that is constantly recycled in coastal

and ocean waters. Algae formed in coastal waters may be carried to coastal wetlands by tides and longshore currents, filtered by bivalves, or deposited with fine sediments. Not all nutrients are endlessly recycled as part of ocean biomass: the deep sea contains large pools of nitrate and phosphate. The net primary production of the oceans depends about 85-90% on recycled nutrients, up to 15% on upwelling zones and only to a small extent on river inputs. Of course, there are large regional variations, and most released nutrients and organic carbon will not reach the deep sea within a timeframe of 20 to 50 years – an omission in most assessments. The best assumption for now may be that 85% of released nutrients are used in renewed primary production as part of the carbon cycle, with a smaller part eventually being sequestered in sediments.

#### 4.2.4 Step 4. Calculation of the ecosystem-based carbon footprint

The final step is to compute and compare the carbon emissions and sequestration between the business-as-usual scenario and the coastal engineering project, taking into account relevant time periods and expected trends and incidents. Depending upon available information and complexity, several aspects of the assessment can be distinguished.

##### 4a: Direct CO<sub>2</sub> emissions of building and dredging

The direct CO<sub>2</sub> emissions from building and dredging, and the CO<sub>2</sub> emissions related to the use of building materials are easily obtainable and can be calculated based on available information.

##### 4b: Direct organic carbon release or sequestration, decay and burial

This includes the effects of the direct release and decay of organic carbon stocks, caused by sediment handling, and organic matter trapped in pits and hydraulic structures. It also includes the difference in carbon sequestration between existing and new land forms and ecosystems, due to land reclamation, capital dredging and wetland creation.

#### 4c: Indirect effects

Indirect effects on carbon stocks and sequestration are mainly related to changes in hydrological conditions and sometimes include off-site effects and changes in sediment budgets.

#### 4d: Inorganic carbon

Inorganic carbon can be a major component of carbon dynamics, but, so far, it has been insufficiently studied. It can be an important factor in the carbon sequestration potential of existing and new coastal sediments and wetlands. It may also be an important factor whenever carbonate-rich sediments are used in land reclamation works.

It is recommended to start researching the ecosystem-based carbon footprint figures early in the project, by first calculating the amount of direct CO<sub>2</sub> emissions related to dredging and building activities and the CO<sub>2</sub> emission that are related to the use of materials. This quickly gives an impression of the amount of CO<sub>2</sub> emissions to be expected. This amount can be compared to CO<sub>2</sub>eq emissions that may be related to organic carbon.

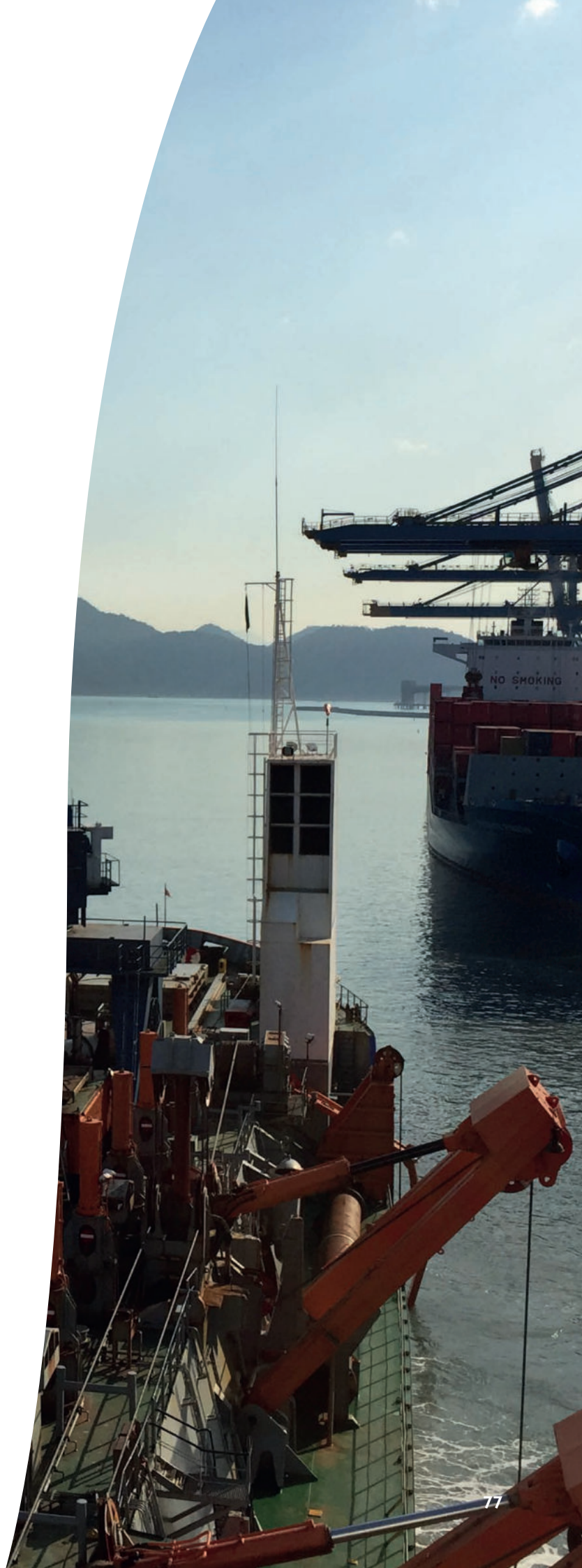

## Chapter 5

# Legislation and policy frameworks

### 5.1 Introduction

In this chapter, we discuss how reduction of GHG emissions and sequestration of carbon in coastal engineering projects can be encouraged and enabled using different policy tools, such as legislation, policy making, financial incentives, education and raising awareness, knowledge and technology development, and innovation. We distinguish three scale levels at which these policy tools can be applied:

- the international or global level;
- the national level;
- the project level.

Using these subdivisions, current frameworks are outlined in Table 5.1. On the international level, agreements have been signed between countries to tackle issues such as climate change and trans-border pollution, e.g. by aviation and shipping in international waters. These agreements often result in national and international policies and legislation. For global sectors that are not regulated at the national level, such agreements have resulted in emission reduction targets by global organisations for shipping (IMO) and aviation (CORSIA). Finally, the project level is where targets have to be put into action.

### 5.2 Current legislative and regulatory frameworks

The current practice of coastal engineering projects in coastal areas is subject to national and international policy frameworks and regulations. During the planning and design phase, there are various regulatory frameworks, containing policy instruments that influence decision making for coastal engineering projects. These instruments include legislation on standards, binding targets and policy goals, financial incentives and knowledge development that determine project targets, financing and methods. While many coastal engineering projects are driven by economic or commercial interests, the way they are implemented is bound by these frameworks. In this

chapter, the key frameworks and instruments that apply to coastal engineering projects on different levels, are discussed – beginning with frameworks that specify GHG emission reduction as their primary goal, followed by frameworks with different primary goals, but potentially with a significant effect on GHG emission reduction in hydraulic engineering projects.

#### *Legislative frameworks for greenhouse gas emission reduction*

The main frameworks for international climate change policy are the United Nations Framework Convention on Climate Change (UNFCCC) (1992), the Kyoto Protocol (1997) and the more recent Paris Agreement (2015), which has currently been ratified by 193 out of 197 Parties to the Convention. The Paris Agreement is a legally binding international treaty to limit global warming to well below 2 degrees Celsius, compared to pre-industrial levels. While it states that 2 °C is the threshold and “pursuing efforts to limit temperature increase to 1.5 °C” is desirable, more recently, the Glasgow Climate Pact has recognised that the impacts of climate change will be much lower after a temperature increase of 1.5 °C compared to 2 °C, and resolves to pursue efforts to limit the temperature increase to 1.5 °C. We therefore continue our discussion with the 1.5 °C target in mind.

Article 5.1 of the Paris agreement states that: “Parties should take action to conserve and enhance, as appropriate, sinks and reservoirs of greenhouse gases (...), including forests.” This is in line with the contribution of Working Group III to the Intergovernmental Panel on Climate Change (IPCC) Fifth Assessment report, which informed the Paris agreement. Working Group III suggests the restoration of forests as a response option for adaptation and mitigation of climate change (Smith et al., 2014). Shukla et al. (2019) also specifically list wetlands, peatlands and mangrove restoration. For compliance with the Paris Agreement, countries have to define their own con-

Table 5.1: Selection of legislative and regulatory frameworks (legally binding), and additional related policy frameworks (non-binding), financial incentives and programmes for knowledge and technology development.

Type	International/ Regional level	National level	Project level
<b>Legislation</b>	UNFCCC/ Paris agreement, EU 2030 Climate Target Plan, European Climate Law, EU LULUCF Regulation, RAMSAR, Natura 2000 (EU), EU water framework directive (WFD), IMO (MARPOL Annex VI and GHG emission targets)	National carbon accounting, binding targets, nationally determined contributions (NDC), standards, enforcement of regulations, designating conservation areas, legally binding targets for nature restoration	Emissions allowances, project carbon footprints, permit-related mitigation requirements
<b>Policy</b>	United Nations sustainable development goals (SDGs), European Climate Change Programme, EU's energy efficiency action plan, EU Biodiversity strategy for 2030, REDD+ (UNFCCC)	CO <sub>2</sub> reduction targets	Project goals, voluntary carbon standards, CO <sub>2</sub> performance ladder, Environmental Impact Assessment
<b>Financial incentives</b>	EU Emissions Trading Scheme (EU ETS), Subsidies: EU LIFE programme, Nature and Biodiversity, EU Innovation fund, InvestEU, European Innovation Council, Sustainable Water Fund (FDW), voluntary carbon markets (e.g. VCS), RRC-EA Wetland Fund 2021	Emissions Trading Scheme (China, New Zealand, California), sulphur dioxide cap and trade programme (US, SO <sub>2</sub> ETS China) funding climate action (e.g. nature based solutions for coastal defence), subsidies, e.g. Coastal and Marine Habitat Restoration Grants (USA), Five Star and Urban Water Restoration Grant Program (USA), Wetland Program Development Grants (USA), Payments for ecosystem services (PES) program under the Forestry Law 7575 in Costa Rica	Financial incentives: subsidies, taxes and cost of carbon allowances
<b>Education and awareness raising</b>	Campaigns, conferences, lobbying	Public campaigns, school curriculum, lobbying	Informing the public about the project
<b>Knowledge and technology development and innovation</b>	Wetlands International studies, EU LIFE programme: Nature and Biodiversity, EU strategy on Climate Adaptation, EU WaterLANDS project	Innovation and research programmes, e.g. National Wetlands R&D Programme	Application of innovative technology, raising awareness, agenda setting, scaling-up solutions

tribution to the common goal with nationally determined contributions (NDC). These are non-binding and discussed in the policy section herein.

### ***Legislative frameworks for pollutant emissions***

In coastal engineering projects, pollutant emission regulations are important, mainly because machinery used in these projects is an important source of air and marine pollution. Dredging vessels, excavators and barges are commonly used in projects and are predominantly powered by diesel combustion engines. The emissions of several air pollutants is regulated by the International Maritime Organisation (IMO) through Annex VI the MARPOL treaty, including sulphur oxides, nitrous oxides and particulate matter from combustion engines. Emission limits are adjusted for the production year of the engine: newer engines have lower limits than older ones. This regulation only covers diesel combustion engines (>130kW) and their resulting emissions, but not the fuel used. Cleaner fuel, for example biobased fuels, will result in lower carbon emissions, but that is not part of the MARPOL Annex VI treaty. The MARPOL treaty is legislation on the international level, but is enforced nationally.

Although the MARPOL treaty is relevant for hydraulic engineering projects, it does not cover carbon emissions. Recently proposed amendments to the MARPOL convention to reduce the carbon intensity of shipping are currently under review.

Specific legislation or regulations applicable to hydraulic engineering projects:

- MARPOL Annex VI (Prevention of Air Pollution from Ships), applicable to all vessels in the maritime environment.

### ***Legislative frameworks for nature conservation***

In coastal areas, nature conservation is an important aspect to consider when planning engineering works. On the international level, the most notable frameworks are the Ramsar Convention on Wetlands of International Importance Especially as Waterfowl Habitat (1971), the Convention on Biological Diversity (CBD, 1993) and the European Natura 2000 network. Every country has included some type of nature conservation in legislation, be it through designated

protected areas, a system of permits, or a requirement for environmental impact assessment. Implementation has to be done on the national level, except for the EU Habitats directive (1992), which established the Natura 2000 network and is legally binding for EU member states. Most importantly for coastal engineering works, nature conservation means that protected areas have to be considered when planning and executing the project.

Another regulatory framework in the EU is the Water Framework Directive (WFD), which dictates that water quality of water bodies may not deteriorate due to human interventions and all water bodies have to be brought to a good chemical and ecological state. Enforcement depends mainly on local authorities, but indirectly, water quality is also affected by climate change (e.g. due to CO<sub>2</sub> dissolution in water and the resulting acidity and higher temperatures). However, these indirect effects of a project are very hard to quantify, since the effect is global.

Besides these examples, it is important to bear in mind that there are several other regional marine and coastal protection conventions.

Specific legislation or regulations applicable to coastal engineering projects:

- For projects within the European Union: Habitats directive establishing the Natura 2000 network, transposed into national legislation. Natura 2000 sites only permit certain types of development and therefore restrict the geographical locations for hydraulic engineering projects. They must also be protected from the potential negative effects of nearby projects.

## **5.3 Current policy frameworks**

In addition to legislative and regulatory frameworks, many policies that aim to reduce GHG emissions are relevant for hydraulic engineering projects. Due to the large variety of policies, we only discuss those that relate to the legislative frameworks in section 5.2. Firstly, frameworks with GHG emission reduction as their primary goal are discussed, followed by frameworks with other primary goals, but which can have a significant effect on GHG emission reductions in hydraulic engineering projects.



### ***Policy frameworks for greenhouse gas emissions reduction***

NDCs summarise a country's climate action plan, whereby it commits to implementing climate policies and to reduce emissions. The countries determine those climate action policies themselves. While many countries are making progress in implementation, only a few are on track to meet their targets (Den Elzen et al., 2019; Boehm et al., 2021). The total of all efforts is presently insufficient to limit global warming to 1.5 °C.

Initiatives in the Land-Use, Land-Use Change and Forestry (LULUCF) sector are sometimes included in NDCs as mitigation or adaptation strategies, for example by EU member states. Most of the countries while accounting for the LULUCF sector input in their NDCs, focus on terrestrial ecosystems. The large part of activities include extending forested lands as removals and very few REDD+ based direct reduction projects. A few countries refer to wetland restoration as removals.

Direct emissions from the land use that are not reported under the National Inventories are as a rule not accounted while preparing the NDCs. For example: when hydraulic engineering activities result in direct emissions from dredging material that has been lifted above the surface, these emissions are not included in national carbon accounting and hence their reduction could not be included in NDCs. There are no unified guidelines on how the direct emissions from ecosystems should be included in NDC or how the mitigation potential of land use change activities should be quantified (Fyson & Jeffery, 2018). Importantly though, there should be no regression from the baseline set by the Kyoto Protocol. This means that all developed countries are expected to have economy-wide targets, which should include all emissions, including from land use change, and including those from non-listed land uses and land categories. Developing countries are also encouraged to move towards economy-wide targets.

In the absence of an international agreement on how LULUCF emissions should be included in NDCs, some signatories to the Paris Agreement are developing

### **REDD+ programme**

REDD+ is a United Nations-backed framework that aims to mitigate climate change by stopping the destruction of forests. REDD stands for "Reducing Emissions from Deforestation and forest Degradation"; the "+" signifies the role of conservation, sustainable management of forests and enhancement of forest carbon stocks. REDD+ helps countries value the carbon and ecosystem services their forests provide, and create financial incentives for reducing deforestation (clearing forests and converting the land to other uses, such as agriculture); reduce degradation (when forests lose their ability to provide ecosystem services); and promote sustainable management (ensuring social, ecological and economic benefits for future generations).

REDD+ is the framework through which states, the private sector, multilateral funds and others can pay countries to not cut down their forests. This can take the form of direct payments or can be in exchange for "carbon credits," which represent reductions in greenhouse gas emissions to compensate for emissions made somewhere else.

*Source: [www.conservation.org](http://www.conservation.org)*

their own methodologies. This is possible, because there is some flexibility in the Paris rulebook with respect to categories of emissions that do not have an IPCC guideline. For this reason, a country can autonomously define LULUCF emissions and devise an accounting methodology for its NDC submission. From 2026, in all EU member states, wetlands (including peatlands) will be subject to LULUCF regulation, which introduces a requirement for GHG emissions from LULUCF to be accounted for, and fully compensated through, action in the sector (European Commission, 2021a). Once a category is included in its NDC, a country should continue to take those sources of emissions into account. Two EU member states have already voluntarily implemented this legislation.

Dredging activities (outside of the LULUCF emissions from wetlands) are exempt from both EU MRV (measuring, reporting and verification) and the EU ETS, due to complexity. Unlike transport vessels, voyages by dredging vessels are exempted from reporting GHG emissions to IMO or the EU (European Commission, 2021b). However, the European Dredging Association has stated it is willing to report CO<sub>2</sub> emissions per vessel, but cannot do so yet due to administrative difficulties (European Dredging Association, 2020).

In addition to countries, hundreds of major companies have set net zero targets (Grace, 2021). These net zero targets often exclude or are unclear about LULUCF emissions and emissions besides CO<sub>2</sub>, and range from all emissions from the entire supply chain (IKEA) to excluding airplane CO<sub>2</sub> emissions from airports (ACIEurope) (Rogelj et al., 2021). Some companies, such as Nestle, include reducing LULUCF emissions in their targets. For many companies, offsetting is essential to reach net zero targets, in line with the mitigation hierarchy (i.e. avoid, reduce and offset) (Black et al., 2021).

### ***Policy frameworks for nature conservation***

Nature conservation policy can have major consequences for hydraulic engineering projects and blue carbon. An ambitious policy framework is the EU Biodiversity Strategy for 2030, which will be in addition to its Habitats Directive. While the goals are currently non-binding, the EU commission will move to make them binding if they have not been achieved by 2024 (European Commission, 2020).

Key pillars are:

- binding targets for nature restoration, especially for degraded and carbon-rich ecosystems,
- legally protecting 30% of land and sea ecosystems (currently 26% and 11%), and
- strict protection (stricter than Natura 2000) of 10% of EU land and seas (currently 3 and 1%), specifically mentioning all carbon-rich ecosystems, such as peatlands, grasslands, wetlands, mangroves and seagrass meadows.

Additionally, environmental impact assessments (EIA) are used in over 100 countries to inform decision makers on the impact of projects, policies or programmes on a wide range environmental values, such as biodiversity and GHG emissions (UN Environment, 2018). The obligation to perform EIAs is usually limited to large scale developments, which often includes coastal engineering projects.

Specific policies applicable to coastal engineering projects:

- LULUCF emissions accounting and reduction policies in EU
- EU Biodiversity strategy 2030, its targets for nature restoration and focus on ecosystems that store carbon.
- EIA, including effects on biodiversity, ecosystem services and climate change.

## **5.4 Financial incentives**

There are several financial mechanisms to promote climate-friendly coastal engineering solutions, including Building with Nature, or to discourage climate-damaging solutions. Those mechanisms include funding schemes, tax schemes and emission trading systems, and require improving carbon accounting.

### ***Carbon accounting***

Carbon accounting is often a prerequisite for financial mechanisms. It is, after all, difficult to manage emissions that are unknown. Carbon accounting can apply to:

- scope 1 emissions (direct), e.g. from dredging ships,
- scope 2 emissions (indirect), e.g. from purchased heating and electricity for own use in offices and
- scope 3 emissions (indirect, from up- and downstream activities). Upstream activities include purchased concrete for hydraulic engineering. Downstream activities are, for example, LULUCF emissions from restored or degraded wetlands and emissions from sediment after construction has been completed.

Including the full scope of emissions in GHG accounting is essential for enabling stakeholders to pursue the most cost-effective carbon mitigation strategies, for implementing measures such as carbon pricing, targets and standards and for the allocation of subsidies (Matthews et al., 2008). If only part of GHG emissions are included in accounting and pricing, emission reduction measures may not be applied to the right sectors. Current carbon accounting systems include EU MRV (monitoring, reporting and validation), Greenhouse Gas Protocol, and ISO 14064 for carbon accounting at organisation and project level. Carbon accounting systems mostly exclude LULUCF emissions from wetlands and hydraulic engineering projects. If emissions and sequestration from wetlands are included in accounting methodology, different rules and frameworks will apply, such as being also included in carbon pricing and in targets set by the EU (Ellison et al., 2014). Supplement to the Greenhouse Gas Protocol is the Corporate Value Chain (Scope 3) Accounting and Reporting Standard (WBCSD/WRI, 2011), the only methodology that currently includes scope 3 LULUCF emissions. Uncertainties around the permanence of blue carbon storage is a reason frequently given for their exclusion from accounting and other funding mechanisms.

### ***Subsidies, grants and private funding***

The most direct way of funding climate-friendly engineering solutions is through either subsidies or private funding. Depending on the importance that government bodies (international, national or local) attach to such activities, subsidies exist on all levels of public administration. Major funds which are relevant for climate-friendly hydraulic engineering projects include the EU Innovation fund, InvestEU, Sustainable Water Fund (FDW), RRC-EA Wetland Fund 2021, Coastal and Marine Habitat Restoration Grants (USA), Five Star and Urban Water Restoration Grant Program (USA) and Wetland Program Development Grants (USA).

Sometimes subsidies intended for another purpose, such as nature conservation, climate-friendly coastal defences or clean development, can reduce carbon emissions or promote carbon sequestration as a side effect (Henderson et al., 2021).

### ***Carbon markets***

Funding for climate-friendly solutions in coastal engineering can also be raised through carbon markets. Carbon markets are marketplaces where entities can sell or buy carbon emissions permits or offset credits (depending on the type of carbon market). There are compliance marketplaces, such as the emission trading schemes (cap-and-trade) in the EU and China, and voluntary markets (Cevallos et al., 2019), where entities can buy offsets on a voluntary basis.

Carbon credits can be used in carbon accounting schemes, such as those related to NDCs. These credits can be traded, so that Parties with fewer mitigation options can buy credits from Parties that have an excess. When climate change mitigation through carbon sequestration in a natural area can be quantified and accounted for, carbon credits can be obtained. These credits are valuable, as they can be traded. Through carbon markets the business case for climate-friendly solutions is improved, because projects that verifiably contribute to climate change mitigation can obtain these valuable credits.

Climate change mitigation efforts in NDCs are mainly focussed on terrestrial ecosystems. However, the first blue carbon conservation methodology was recently developed (Verra, 2020). Furthermore, several EU members (e.g. Ireland) account for managed wetlands in their National Inventory Submission and the EU is planning to mandate the same for all members from 2026 (Barthelmes, 2018). Since 2021, the EU has also required emissions from land use to be net zero and has allowed Member States to trade recognised removals.

The Blue Carbon Initiative strives for including blue carbon wetlands in carbon accounting schemes. This is a well-intentioned initiative, but we should bear in mind that carbon credits only cover part of the total economic value of blue carbon wetlands. Other important economic benefits include protection against floods, tsunamis and coastal erosion, supporting biodiversity, fisheries, recreation, etc. (Davidson et al., 2019). Additional finance solutions, such as payments for ecosystem services or ecological fiscal transfer, have been implemented to take into account the wider array of benefits from nature conservation (Schuhmann, 2020).

Several private funding mechanisms, including by NGOs, for climate-friendly hydraulic engineering solutions in wetlands exist. One such private funding scheme is the Blue Natural Capital Financing Facility (BNCFF), which is managed by the International Union for Conservation of Nature (IUCN). The BNCFF supports, among other natural capital solutions, blue carbon projects, by providing structured investment opportunities and reducing investment risks.

### **Carbon tax**

Another mechanism to promote climate-friendly hydraulic engineering solutions is through a carbon tax. Instead of providing credits for climate-friendly solutions, a carbon tax makes climate-damaging solutions financially less attractive, by including externalities of GHG emissions in the cost of the project. Although there is no global carbon tax scheme in place, there are several regional and national schemes. These tax schemes cover only part of GHG emissions. Excluded from most of these tax schemes are international industries such as aviation and shipping, and (direct) emissions from land use. However, countries such as Sweden and the UK, are set to include these emissions in certain sectors. Tax schemes are found to be twice as effective in reducing carbon emissions from land use, land use change and forestry (LULUCF), compared to subsidies (Henderson et al., 2021). The effectiveness of carbon tax schemes for reducing GHG emissions is improved when carbon leakage is pre-

vented and the full scope of carbon emissions, including blue carbon, are covered by the tax scheme.

## **5.5 Education and awareness raising**

The present report outlines a number of solutions; technical methods, legislative, regulatory and policy frameworks and funding mechanisms to reduce GHG emissions from hydraulic engineering projects and increase blue carbon sequestration. Furthermore, the environmental impacts of dredging, sludge use, hydraulic structures, land reclamation and coastal wetlands are often not considered in decision making and are excluded from current climate policies. These impacts need to be recognized and the solutions, frameworks and mechanisms – implemented. For that purpose, relevant actors have to be informed about these solutions - through conferences, workshops on this issue, press releases, disseminating information through media platforms, directly lobbying decision makers, creating and spreading educational materials. Willingness to act can be fostered by mobilizing public opinion to influence decision makers. These topics are important and require further examination, but are beyond the scope of this research.

## **5.6 Knowledge development and innovation**

### **Knowledge development**

Enhanced understanding of GHG emissions from hydraulic engineering and blue carbon sequestration can facilitate the implementation of measures to reduce emissions. High uncertainty around GHG sequestration in coastal ecosystems and emissions from hydraulic engineering projects is commonly cited as a reason for excluding them from carbon accounting. As described in 5.4, however, carbon accounting is a prerequisite for many policy instruments to apply; this goal is worth pursuing because of the potential magnitude of GHG emissions from hydraulic engineering projects. Thus, research aimed at reducing uncertainties may be a good investment. This report identifies the following knowledge gaps and opportunities for further research:

- The transformation of organic matter in waterways and harbour basins in relation to shipping and dredging activities.
- The role of inorganic carbon
- Spatio-temporal data regarding:
  - carbon sequestration rates in certain types of wetlands and coastal sediments in specific regions
  - different methane flux pathways with global coverage
  - methane emission from different types of habitat
  - lateral export of DIC and TA
  - the permanence of blue carbon storage in different ecosystems.
- What happens to the exported DIC and whether it contributes to carbon sequestration, e.g. establishing whether a mangrove forest mineralizes more carbon than it produces.

#### Technological development and innovation

Approaches such as carbon burial in hydraulic engineering projects and wetland restoration and creation are not common practice around the world. To make these methods more desirable, we suggest research into:

- Innovative methods and/or best practices to effectively restore or create wetlands (at low cost).
- Creating methods or best practices to implement the burial of sediments with high (labile) organic matter in hydraulic engineering projects.

Besides these technical questions, further research on social dynamics, and socio-economic and political aspects would also be beneficial, but were beyond the scope of this report.

## 5.7 Conclusions

Nature conservation legislation and policies mandating the restoration of carbon-rich coastal and wetland ecosystems provide opportunities for capturing blue carbon. The EU Habitats directive limits conventional hydraulic engineering projects on sites included in the Natura 2000 network. Biodiversity frameworks provide targets for nature restoration and a focus on ecosystems that store carbon. Environmental impact assessments facilitate the inclusion of effects on bio-

diversity, ecosystem services and climate change into decision making.

Globally, the Paris Agreement requires action to minimize GHG emissions and enhance carbon sinks, but most countries have not yet adopted blue carbon strategies. Moreover, GHG emissions from hydraulic engineering projects are rarely included in carbon accounting and carbon pricing. Incorporating the full scope of GHG emissions into national carbon accounting - including those associated with coastal ecosystems and dredging activities - is essential for optimising carbon mitigation strategies, reducing cost, and implementing incentives such as carbon pricing, targets and standards and allocating subsidies for mitigation. The ecosystem-based carbon footprinting methodology outlined in this report enables accounting for the full scope of emissions and suggests approaches to dealing with uncertainties.

Nations and other actors in the water sector can support climate- and ecosystem-friendly hydraulic engineering by adopting GHG reduction targets for the sector and by setting standards as requirement for permits or licenses. To successfully minimise carbon emissions, national policies and legislation need to be translated into project goals and tasks at the appropriate stages for design and engineering firms, contractors and maintainers overseen by the project commissioner.

Since the business case for climate- and ecosystem-friendly hydraulic engineering, in the context of a free market, is not yet sufficiently strong, additional funding mechanisms and the pricing of externalities are crucial. The most cost-effective solution is carbon pricing, through either a carbon market or carbon tax. Further financial incentives can be provided by subsidising projects that purposefully sequester blue carbon, through voluntary carbon markets, by direct payments for wetland restoration, or by creating funding streams for the co-benefits of wetland restoration.

A large-scale industrial structure, possibly an offshore oil rig or a power plant tower, is silhouetted against a bright, hazy sunset sky. The structure consists of a complex network of steel beams and platforms. A crane arm extends from the left side. The sun is low on the horizon, creating a strong glow and casting long shadows. The bottom portion of the image is overlaid with a dark blue gradient that contains the text.

# Appendices

## Appendix I

# Glossary

Term	Explanation
<b>Blue carbon wetlands</b>	Blue carbon wetlands are coastal wetlands with a high carbon density, such as mangroves, salt marshes and sea grass beds. They are situated in the intertidal zone and store high quantities of carbon.
<b>Carbon cycle</b>	The carbon cycle is a complex balance of processes that ultimately determine whether a system acts as a net carbon sink or source.
<b>Coastal carbon sequestration landscape</b>	The total of soils, sediments and biomass in a coastal landscape.
<b>C/N ratio</b>	Ratio of carbon and nitrogen [g/g]
<b>C/P ratio</b>	Ratio of carbon and phosphorus [g/g]
<b>C/fines ratio</b>	Ratio of carbon and fine sediment particles [g/g]
<b>DIC</b>	Dissolved inorganic carbon: different forms of dissolved CO <sub>2</sub>
<b>DOC</b>	Dissolved organic carbon
<b>Dredging</b>	Dredging is the excavation of material from a water body. Two main types of dredging can be discerned: capital dredging (C.1) and maintenance dredging (C.2). Capital dredging is the removal of material for the creation of harbours, waterways or navigation channels. Maintenance dredging is excavation for maintenance purposes in or around existing objects. The goal of maintenance dredging can be either to improve water quality by removing sludge (C.2.1) or to maintain a specific (navigable) depth in the water body (C.2.2). Maintenance dredging can be done with three methods: mechanical dredging, hydraulic dredging or through water injection.
<b>Fines</b>	A term commonly used for clay and silt.
<b>Hydraulic engineering project</b>	Set of human interventions that occur in coastal and marine systems. These interventions may range from infrastructure works (e.g. dredging for navigation) to a Building with Nature solution for coastal defence (e.g. wetland restoration).
<b>GHG</b>	Greenhouse gas
<b>Humins</b>	Humins are carbon-based macromolecular substances, that can be found in <a href="https://en.wikipedia.org/wiki/Soil_chemistry">https://en.wikipedia.org/wiki/Soil_chemistry</a> . Soil consists of both mineral (inorganic) and organic components. The organic components can be subdivided into fractions that are soluble, largely humic acids, and insoluble, the humins. Humins make up about 50% of the organic matter in soil. (Rice, 2001). James A. "Humin" Soil Science 2001, vol. 166(11), pp. 848-857. <a href="https://journals.lww.com/soilsci/Abstract/2001/11000/HUMIC_SUBSTANCES__CONSIDERATIONS_OF_COMPOSITIONS,.2.aspx">https://journals.lww.com/soilsci/Abstract/2001/11000/HUMIC_SUBSTANCES__CONSIDERATIONS_OF_COMPOSITIONS,.2.aspx</a>

Term	Explanation
<b>Labile organic matter</b>	Organic matter that is still subject to decay, so C and nutrients are easily released.
<b>Longshore transport</b>	Sediment transport along the coast
<b>Marine landscape</b>	see Seascape
<b>NDC</b>	Nationally determined contributions. NDCs embody efforts to reduce national emissions and adapt to the impacts of climate change
<b>PIC</b>	Particulate Inorganic Carbon, such as shell fragments
<b>POC</b>	Particulate organic carbon
<b>Redfield ratio</b>	The Redfield ratio indicates how much C, N, P and also Fe and Si in the case of diatoms, is needed for primary production. When one of these elements is present in an amount smaller than needed, it may be limiting primary production.
<b>Seascape</b>	"A spatially heterogeneous marine region that can be delineated at a range of scales and which includes physical, geological and chemical aspects of oceans. It can be a combination of adjacent coastline and sea, such as mangroves, coral reefs, seagrass beds, tidal marshes and deep seas. It includes the features of the geology and morphology of the sea floor as well as the living communities of the benthos, water column and surface, and often includes the influence of humans (Fuller, 2013; Pittman, 2017). Seascapes are generally large, but can be defined at a range of spatial scales."(Hilty et al., 2020)
<b>Sequestration efficiency</b>	Efficiency can be defined with reference to surface area, a definition most commonly used, but also with reference to primary production and nutrients and fine sediments especially when they are available in limiting quantities.
<b>SOC</b>	Soil organic carbon content
<b>Recalcitrant organic matter</b>	Organic matter that no longer decays, or only decays very little. It behaves more or less neutral.
<b>REDD+ programme</b>	United Nations Collaborative Programme on Reducing Emissions from Deforestation and Forest Degradation in Developing Countries. The overall development goal of the Programme is to reduce forest emissions and enhance carbon stocks in forests while contributing to national sustainable development. Put simply, REDD+ is the framework through which countries, the private sector, multilateral funds and others can pay countries to not cut down their forests. As countries are trying to meet their Paris Agreement targets, or nationally determined contributions, REDD+ can help countries get there. It creates a financial value for the carbon stored in forests by offering incentives for developing countries to reduce emissions from forested lands and invest in low-carbon paths to sustainable development. Developing countries would receive results-based payments for results-based actions.



## Appendix II

# Recommended further reading

### **[1] Methane emissions:**

- [1] J.A.Rosentreter. Methane in Coastal Blue Carbon Ecosystems. PPT on internet.
- [2] L.C. Jeffrey. Et al. 2019. Are Methane emissions from mangrove stems a cryptic carbon loss pathway? Insights from a catastrophic forest mortality.
- [3] J.A.Rosentreter. et al. 2018. Methane emissions partially offset "blue carbon" burial in mangroves. Science advances, Vol.4. no.6.
- [4] Chiao-Wen Li t al. 2020/ Methane Emissions from subtropical and Tropical Mangrove Systems in Taiwan. Forests.

### **[2] Dredging plumes and coastal erosion**

- Most studies focus on turbidity and the effects on coral reefs. There is limited information on water quality effects in terms of algal growth and benthic production. With new satellites, such as Sentinel, it becomes possible to also monitor algal/chlorophyll. This was, for example, done in Lake Marker which is a P-limited lake. A dredging plumes developed over nearly 8 km with substantial increase in primary production from 4 km onwards, due to the release of nutrients. Similar water quality effects were predicted by a water quality model for the proposed dredging works needed to construct the airport island for Schiphol. Another important effect is the burial of benthic communities by settling of sediment. Depending on hydraulic conditions, this burial can be temporary or long lasting.
- [1] R.Fisher et al. Spatial pattern in water quality changes during dredging in Tropical Environments. 2015. In Plos One.

### **[3] Decay and inert organics material**

There is limited data on the % of reactive organic carbon in soils, sediments and as POC in the water column. Given enough time, all organic material will decompose and mineralize, but this could take thousands of years. More relevant would be organic material that is mineralized within several decades, either in the presence of oxygen or due to anaerobic processes. Organic material that is truly inert forms a neutral element in carbon stocks and will not be lost to the atmosphere for example in the case of erosion. There may be information that gives a indication what might be the % of inert organic C in different types of sediments and wetlands types. We know, for example, that organic C in Pleistocene sands, which are used for nourishment in the Netherlands have a high percentage of inert organic carbon. This may be explained by their age, their texture and the sedimentation conditions, which were turbulent with sufficient oxygen available for decay. The percentage of inert organic C is much lower in recently developed mudflats, because their age is short, oxygen availability is limited.

### **Carbon burial path off site, nutrient limitation to primary production**

- This category covers also coastal sediments and not only soils and sediments in blue carbon wetlands. Their importance relates also to the lateral export and interactions between a blue carbon wetland and the coastal waters (see also below).
- [1] Global biochemical cycles. Regional variation in the particular organic carbon to nitrogen ratio in the surface ocean. By A.C. Martiny et al. 2013. In Advanced Earth and Space Science.

[2] Soil organic carbon stocks in estuarine and marine mangrove ecosystems are driven by nutrient colimitation of P and N. By C.Weiss et al. In Ecology and Evolution.

[3] Nutrient variability in mangrove soils: anthropogenic, seasonal and depth variations factors. By A.B. Sofawi. 2017.

[4] Concentrations and ratios of particulate organic carbon, nitrogen and phosphorus in the global ocean. 2014. In: Scientific data.

[5] Ocean nutrient ratios governed by plankton biogeography. By T.S. Weber and C. Deutsch.

[6] Nutrient supply controls particular elemental concentrations and ratios in the low latitude eastern Indian Ocean. By C.A. Garcia et al. 2018. In Nature Communications.

The elemental stoichiometry (C,Si.N.P) of the Hebrides Shelf and its role in carbon export. By S.Painter et al. 2017. In Progress in Oceanography.

### ***Interaction mangrove and ocean, lateral transport mechanisms***

A large proportion of the POC exported by mangroves settles nearby, for example in sea grass beds. Lateral export also includes studies that looked at DIC export by mangroves and salt marshes. A major knowledge gap is what happens to the exported DIC, does it contribute to carbon sequestration? These studies mostly focus on C in different forms and not on nutrients. So it is difficult to establish whether, for example, a mangrove mineralizes more carbon than it produces.

[1] Bouillion S. et al 2007. Dynamics of organic and inorganic carbon across continuous mangrove and seagrass systems (Gazi Bay, Kenya). Journal of Geophysical Research Biogeosciences. Volume 112, Issue G2, June 2007.

[2] D.T. Maher. Et al. 2018. Beyond burial: lateral exchange is a significant atmospheric carbon sink in mangrove forests. Biological Letters. Volume 14, Issue 7.

[3] D.A. Saavedra-Hortue et al. 2020. Sources of Particulate Organic Mater across Mangrove Forests and Adjacent Ecosystems in Different Geomorphic Settings. In Wetlands 40 1047-1059.

[4] J.T. Tamborski et al. 2021. Pore water exchange-driven inorganic carbon export from intertidal salt marshes. Limnology and oceanography.

### ***Sequestration efficiency in different sedimentation environments***

It is relevant to distinguish different types of sedimentation environments and their potential to sequester carbon in terms of stocks, accumulation rates and the efficiency with which carbon is sequestered in presence of fine sediments and nutrients. Carbon burial and the relation between sedimentation rate, texture and type and TOC, TIC and related C/N, NP and C/P ratio. It is especially critical in order to define off-site effects. This will help to define the settings, such as:

[1] M.E.Gonneea et al. 2004. Tracing organic matter sources and carbon burial in mangrove sediments over the past 160 years. In Estuarine coastal shelf science.

[2] Organic carbon burial and sources in soils of coastal mudflat and mangrove ecosystems. By S.D. Sasmito et al. 2020. Catena volume 187.

[3] Carbon burial in deep sea sediments and implications for oceanic inventories of carbon and alkalinity over the last glacial cycle. Olivier Cartapanis et al. 2018.

[4] M.Kida and N.Fujitake. 2020. Organic Carbon stabilization mechanisms in mangrove soils: A review. In: Forests.

[5] C.O.Quintana et al. 2015. Carbon mineralization pathways and bioturbation in coastal Brazilian sediments. Scientific reports.

Sediment Properties as Important Predictors of Carbon Storage in *Zostera marina* meadows: A comparison of Four European Areas. By M.Dahl, D. Deyanova and M. Gullstrom. 2016. In Plos One.

Drivers and modelling of blue carbon stock variability in sediments of southeastern Australia. By C.J. Ewers Lewis et al/ 2020. In Biogeosciences 17.

Carbon to phosphorus ratios in sediments: Implications for nutrient recycling. By L.D.Anderson, M.I. Delaney and K.L. Faul. 2001. In: Global Biogeochemical cycles, Vol. 15.

Carbon and Phosphorus Cycling in Arabian Sea Sediments across the Oxygen Minimum Zone. By G.M.Filippelli and G.L.Cowie. In: Journal of Oceanography and Marine Research.

Relevance of carbon stocks of marine sediments for national greenhouse gas inventories of maritime nations. Sylvania Avelar et al. 2017. In Carbon balance and management.

J.J.Middelburg. 2019. Carbon processing at the sea floor. Marine Carbon Biochemistry.

### ***Global studies and characteristics, mostly stocks***

[1] A global map of mangrove forest soil carbon at 30 m spatial resolutions. By J.Sanderman and T.Hengl. Environmental Research letters, 2018.

[2] ORFOIS: Origen and fate of biogenic particle fluxes in the ocean and their interaction with atmospheric CO<sub>2</sub> concentrations as well as the marine sediment. By N.Dittert et al. Technical report. 2000.

[3] D.M. Alongi. 2020. Carbon Cycling in the World's mangrove Ecosystems Revisited: Significance of Non-steady state diagnosis and subsurface linkages between the forest floor and the coastal ocean. In: Forests.

[4] Global controls on carbon storage in mangrove soils. A.S. Rovai et al. In: Nature Climate Change.

[5] Carbon burial in deep-sea sediment and implications for oceanic inventories of carbon and alkalinity over the last glacial cycle. O.Cartapanis et al. 2018. In Climatic past. 14.

[6] Total ecosystem carbon stocks of mangroves across broad global environmental and physical gradients. By B. Kaufmann et al. 2020. Ecological Monographs.

### ***Global studies on carbon sequestration***

[1] T.C.Jennerjahn. n.d. Relevance and magnitude of Blue Carbon storage in mangrove sediments: carbon accumulation rates vs.stocks, sources vs. sinks. Elsevier. Estuarine, Coastal and Shelf Science.

[2] A.Perez et al. 2018. Factors influencing organic carbon accumulation in mangrove ecosystems

### ***Regional studies and regional factors and variation***

[1] Where's the Carbon: Exploring the spatial Heterogeneity of sedimentary carbon in Mid Latitude Fjords. By C.Smeaton and W.E.N. Austin. 2019.

[2] TOC as a regional sediment condition indicator: parsing effects of grain size and organic content. By W.G. Nelson et al. 2011.

[3] J.A. Hutchings et al. 2020. Carbon Deposition and Burial in Estuarine Sediments of the Contiguous United States. In Global Biochemical Cycles.

[4] Bin Deng et al. 2006. Recent sediment accumulation and carbon burial in the East China Sea. Biochemical Cycles

## Appendix III

# References

- Alongi, D. M. (2014). Carbon cycling and storage in mangrove forests. *Annual Review of Marine Science*, 6, 195–219. <https://doi.org/10.1146/annurev-marine-010213-135020>
- Alongi, D. M. (2020a). Carbon balance in salt marsh and mangrove ecosystems: A global synthesis. *Journal of Marine Science and Engineering*, 8(10), 1–21. <https://doi.org/10.3390/jmse8100767>
- Alongi, D. M. (2020b). Carbon cycling in the world's mangrove ecosystems revisited: Significance of non-steady state diagenesis and subsurface linkages between the forest floor and the coastal ocean. *Forests*, 11(9), 1–17. <https://doi.org/10.3390/f11090977>
- Alongi, D. M. (2020c). Global Significance of Mangrove Blue Carbon in Climate Change Mitigation. *Sci*, 2(67), 1–15. <https://doi.org/10.3390/sci2030067>
- Asaoka S, Umehara A, Haga Y, Matsumura C, Yoshiki R, Takeda K. Persistent organic pollutants are still present in surface marine sediments from the Seto Inland Sea, Japan. *Mar Pollut Bull*. 2019 Dec;149:110543. doi: 10.1016/j.marpolbul.2019.110543. Epub 2019 Sep 5. PMID: 31543483.
- Atwood, T. B., Connolly, R. M., Almahasheer, H., Carnell, P. E., Duarte, C. M., Lewis, C. J. E., Irigoien, X., Kelleway, J. J., Lavery, P. S., Macreadie, P. I., Serrano, O., Sanders, C. J., Santos, I., Steven, A. D. L., & Lovelock, C. E. (2017). Global patterns in mangrove soil carbon stocks and losses. *Nature Climate Change*, 7(7), 523–528. <https://doi.org/10.1038/nclimate3326>
- Barthelmes, A. (2018). Reporting greenhouse gas emissions from organic soils in the European Union: Challenges and opportunities. Policy brief, 1-16.
- Black, R., Cullen, K., Fay, B., Hale, T., Lang, J., Mahmood, S., Smith, S.M. (2021). Taking Stock: A global assessment of net zero targets, Energy & Climate Intelligence Unit and Oxford Net Zero
- Bridgham, S. D., Cadillo-Quiroz, H., Keller, J. K., & Zhuang, Q. (2013). Methane emissions from wetlands: Biogeochemical, microbial, and modeling perspectives from local to global scales. *Global Change Biology*, 19(5), 1325–1346. <https://doi.org/10.1111/gcb.12131>
- Bouw, M. & Van Eekelen E. Building with Nature - Creating, implementing and upscaling Nature-based Solutions. Nai Publishers. 2020
- Boehm, S., K. Lebling, K. Levin, H. Fekete, J. Jaeger, R. Waite, A. Nilsson, J. Thwaites, R. Wilson, A. Geiges, C. Schummer, M. Dennis, K. Ross, S. Castellanos, R. Shrestha, N. Singh, M. Weisse, L. Lazer, L. Jeffery, L. Freehafer, E. Gray, L. Zhou, M. Gidden, and M. Gavin. 2021. State of Climate Action 2021: Systems Transformations Required to Limit Global Warming to 1.5°C. Washington, DC: World Resources Institute: <https://doi.org/10.46830/wriprt.21.00048>.
- Bunting, P., Rosenqvist, A., Lucas, R. M., Rebelo, L. M., Hilarides, L., Thomas, N., Hardy, A., Itoh, T., Shimada, M., & Finlayson, C. M. (2018). The global mangrove watch - A new 2010 global baseline of mangrove extent. *Remote Sensing*, 10(10). <https://doi.org/10.3390/rs10101669>
- Cevallos, G., Grimault, J., & Bellassen, V. (2019). Domestic carbon standards in Europe-Overview and perspectives (Doctoral dissertation, Inconnu).
- Davidson, N. C., & Finlayson, C. M. (2019). Updating global coastal wetland areas presented in Davidson and Finlayson (2018). *Marine and Freshwater Research*, 70(8), 1195–1200. <https://doi.org/10.1071/MF19010>
- Den Elzen, M., Kuramochi, T., Höhne, N., Cantzler, J., Esmeijer, K., Fekete, H., ... & Vandyck, T. (2019). Are the G20 economies making enough progress to meet their NDC targets?. *Energy policy*, 126, 238-250.
- Duarte, C. M., Losada, I. J., Hendriks, I. E., Mazarrasa, I., & Marbà, N. (2013). The role of coastal plant communities for climate change mitigation and adaptation. *Nature Climate Change*, 3(11), 961–968. <https://doi.org/10.1038/nclimate1970>
- Ellison, D., Lundblad, M., & Petersson, H. (2014). Reforming the EU approach to LULUCF and the climate policy framework. *Environmental science & policy*, 40, 1-15.
- European Commission (2020), EU Biodiversity Strategy for 2030, .

- European Commission (2021a): Proposal for a REGULATION OF THE EUROPEAN PARLIAMENT AND OF THE COUNCIL amending Regulations (EU) 2018/841 as regards the scope, simplifying the compliance rules, setting out the targets of the Member States for 2030 and committing to the collective achievement of climate neutrality by 2035 in the land use, forestry and agriculture sector, and (EU) 2018/1999 as regards improvement in monitoring, reporting, tracking of progress and review. <https://eurlex.europa.eu/legal-content/EN/TXT/?uri=CELEX:52021PC0554>.
- European Commission (2021b, July 14). Questions and Answers - Emissions Trading – Putting a Price on carbon. [https://ec.europa.eu/commission/presscorner/detail/en/qanda\\_21\\_3542](https://ec.europa.eu/commission/presscorner/detail/en/qanda_21_3542)
- European dredging association (2020). European dredging association position paper on
- Decarbonisation of dredging projects. Brussels, Belgium. [http://european-dredging.eu/pdf/EuDA\\_policy\\_paper\\_on\\_dredging\\_decarbonisation.pdf](http://european-dredging.eu/pdf/EuDA_policy_paper_on_dredging_decarbonisation.pdf)
- Fiselier and Vreeman (2012) Carbon footprinting marine BWN projects. Quick scan of approaches, knowledge caps and footprints of BwN concepts and projects. Assignment of Ecoshape to Royal HaskoningDHV, 10th of November 2012
- Fourqurean, J. W., Duarte, C. M., Kennedy, H., Marbà, N., Holmer, M., Mateo, M. A., Apostolaki, E. T., Kendrick, G. A., & Krause-jensen, D. (2012). Seagrass ecosystems as a globally significant carbon stock. *Nature Geoscience*, 5(July), 505–509. <https://doi.org/10.1038/ngeo1477>
- Fuller, B. J. C. (2013). Advantage in seascape ecology: applying landscape metrics to marine systems. *Ecology of Fragmented Landscapes*, 6(April), 257–259. <http://www.ncbi.nlm.nih.gov/pubmed/25113780>
- Fyson, C., & Jeffery, L. (2018). Examining treatment of the LULUCF sector in the NDCs. In EGU General Assembly Conference Abstracts (p. 16542).
- Grace, M. (2021, February 5). Companies that have set net zero targets. <https://carbon.ci/insights/companies-with-net-zero-targets/>
- Green EP, Short FT (2003). World atlas of seagrasses. Prepared by UNEP World Conservation Monitoring Centre. Berkeley (California, USA): University of California
- Gregg, R., Elias, J. L., Alonso, I., Crosher, I.E., Muto, P. and Morecroft, M.D. (2021) Carbon storage and sequestration by habitat: a review of the evidence (second edition) Natural England Research Report NERR094. Natural England, York.
- Hamilton, S. E., & Casey, D. (2016). Creation of a high spatio-temporal resolution global database of continuous mangrove forest cover for the 21st century (CGMFC-21). *Global Ecology and Biogeography*, 25(6), 729–738. <https://doi.org/10.1111/geb.12449>
- Henderson, B., Frank, S., Havlik, P., & Valin, H. (2021). Policy strategies and challenges for climate change mitigation in the Agriculture, Forestry and Other Land Use (AFOLU) sector.
- Hilty, J., Worboys, G. L., Keeley, A., Woodley, S., Lausche, B. J., Locke, H., Carr, M., Pulsford, I., Pittock, J., White, J. W., Theobald, D. M., Levine, J., Reuling, M., Watson, J. E. M., Ament, R., & Tabor, G. M. (2020). Guidelines for conserving connectivity through ecological networks and corridors. *Guidelines for Conserving Connectivity through Ecological Networks and Corridors*, 30. <https://doi.org/10.2305/iucn.ch.2020.pag.30.en>
- Kauffman, J. B., Fernanda Adame, M., Budi Arifanti, V., Schillebeers, L. M., Bernardino, A. F., Bhomia, R. K., Donato, D. C., Feller, I. C., Ferreira, T. O., Del Carmen Jesus Garcia, M., MacKenzie, R. A., Megonigal, J. P., Murdiyarso, D., Simpson, L., & Hernandez Trejo, H. (2020). Total ecosystem carbon stocks of mangroves across broad global environmental and physical gradients. *Ecological Monographs*, 90(2), 1–18. <https://doi.org/10.1002/ecm.1405>
- Kavanaugh, M. T., Oliver, M. J., Chavez, F. P., Letelier, R. M., Muller-Karger, F. E., & Doney, S. C. (2016). Seascapes as a new vernacular for pelagic ocean monitoring, management and conservation. *ICES Journal of Marine Science*, 73(7), 1839–1850. <https://doi.org/10.1093/icesjms/fsw086>

- Kennedy, H., Beggins, J., Duarte, C. M., Fourqurean, J. W., Holmer, M., Marbà, N., & Middelburg, J. J. (2010). Seagrass sediments as a global carbon sink : Isotopic constraints. 24(April), 1–8. <https://doi.org/10.1029/2010GB003848>
- Kuwae, T., & Hori, M. (2019). Blue Carbon in Shallow Coastal Ecosystems. In T. Kuwae & M. Hori (Eds.), *Blue Carbon in Shallow Coastal Ecosystems*. Springer Singapore. <https://doi.org/10.1007/978-981-13-1295-3>
- Lamb, Angela L., Graham P. Wilson, Melanie J. Leng (2006), A review of coastal palaeoclimate and relative sea-level reconstructions using  $\delta^{13}C$  and C/N ratios in organic material, *Earth-Science Reviews*, Volume 75, Issues 1–4, 2006, Pages 29–57,
- Lin, W.J., Chiu, M.-C., Lin, C.-W., & Lin, H.-J. (2021). Effects of Sediment Characteristics on Carbon Dioxide Fluxes Based on Interacting Factors in Unvegetated Tidal Flats. *Frontiers in Marine Science*, 8(May). <https://doi.org/10.3389/fmars.2021.670180>
- Lin, W.J., Wu, J., & Lin, H. J. (2020). Contribution of unvegetated tidal flats to coastal carbon flux. *Global Change Biology*, 26(6), 3443–3454. <https://doi.org/10.1111/gcb.15107>
- Liu, Qinyu, Yingtong Liang, Wei-Jun Cai, Kuo Wang, Kedong Yin. 2020. Changing riverine organic C:N ratios along the Pearl River: Implications for estuarine and coastal carbon cycles. *Science of the total Environment* 709 136052.
- Mackenzie, R., Sharma, S., & Rovai, A. R. (2021). Environmental drivers of blue carbon burial and soil carbon stocks in mangrove forests. In *Dynamic sedimentary environments of mangrove coasts* (pp. 275–294). Elsevier Inc.
- Macreadie, P. I., Anton, A., Raven, J. A., Beaumont, N., Connolly, R. M., Friess, D. A., Kelleway, J. J., Kennedy, H., Kuwae, T., Lavery, P. S., Lovelock, C. E., Smale, D. A., Apostolaki, E. T., Atwood, T. B., Baldock, J., Bianchi, T. S., Chmura, G. L., Eyre, B. D., Fourqurean, J. W., ... Duarte, C. M. (2019). The future of Blue Carbon science. *Nature Communications*, 10(1), 1–13. <https://doi.org/10.1038/s41467-019-11693-w>
- Martin, A., Landis, E., Bryson, C., Lynaugh, S., Mongeau, A., and Lutz, S. (2016). Blue Carbon - Nationally Determined Contributions Inventory. Appendix to: Coastal blue carbon ecosystems. Opportunities for Nationally Determined Contributions. Published by GRIDArendal, Norway.
- Matthews, H. S., Hendrickson, C. T., & Weber, C. L. (2008). The importance of carbon footprint estimation boundaries. Mcowen, C. J., Weatherdon, L. V., Van Bochove, J. W., Sullivan, E., Blyth, S., Zockler, C., Stanwell-Smith, D., Kingston, N., Martin, C. S., Spalding, M., & Fletcher, S. (2017). A global map of saltmarshes. *Biodiversity Data Journal*, 5(1). <https://doi.org/10.3897/BDJ.5.e11764>
- Murray, N. J., Phinn, S. R., DeWitt, M., Ferrari, R., Johnston, R., Lyons, M. B., Clinton, N., Thau, D., & Fuller, R. A. (2019). The global distribution and trajectory of tidal flats. *Nature*, 565(7738), 222–225. <https://doi.org/10.1038/s41586-018-0805-8>
- Nellemann, C., Corcoran, E., Duarte, C. M., Valdés, L., De Young, C., Fonseca, L., & Grimsditch, G. (2009). Blue carbon: A Rapid Response Assessment. In *Environment*. [http://www.grida.no/files/publications/blue-carbon/BlueCarbon\\_screen.pdf](http://www.grida.no/files/publications/blue-carbon/BlueCarbon_screen.pdf)
- Pendleton, L., Donato, D. C., Murray, B. C., Crooks, S., Jenkins, W. A., Sifleet, S., Craft, C., Fourqurean, J. W., Kauffman, J. B., Marbà, N., Megonigal, P., Pidgeon, E., Herr, D., Gordon, D., & Baldera, A. (2012). Estimating Global "Blue Carbon" Emissions from Conversion and Degradation of Vegetated Coastal Ecosystems. *PLoS ONE*, 7(9). <https://doi.org/10.1371/journal.pone.0043542>
- Pittman, S. J. (2017). *Seascape Ecology* (Issue November). Wiley-Blackwell Publishing Ltd.
- Pittman, S. J., Wiens, J. A., Wu, J., & Urban, D. L. (2018). Landscape ecologists' perspectives on seascape ecology. *Seascape Ecology*, 485–492. <https://www.wiley.com/en-us/Seascape+Ecology-p-9781119084433>
- Poffenbarger, H. J., Needelman, B. A., & Megonigal, J. P. (2011). Salinity influence on methane emissions from tidal marshes. *Wetlands*, 31(5), 831–842. <https://doi.org/10.1007/s13157-011-0197-0>
- Rice, James A. "Humin" *Soil Science* 2001, vol. 166(11), pp. 848-857. :
- Rogelj, J., Geden, O., Cowie, A., & Reisinger, A. (2021). Three ways to improve net-zero emissions targets. *Nature*, 591(7850), 365–368.
- Rosentreter, J. A., Borges, A. V., Deemer, B. R., Holgerson, M. A., Liu, S., Song, C., Melack, J., Raymond, P. A., Duarte, C. M., Allen, G. H., Olefeldt, D., Poulter, B., Battin, T. I., & Eyre, B. D. (2021). Hlaf of glboal methane emissions come from highly variable aquatic ecosystem sources. *Nature Geoscience*, 14(April), 225–230. <https://doi.org/10.1038/s41561-021-00715-2>

- Sanderman, J., Hengl, T., Fiske, G., Solvik, K., Adame, M. F., Benson, L., Bukoski, J. J., Carnell, P., Cifuentes-Jara, M., Donato, D., Duncan, C., Eid, E. M., Ermgassen, P. Z., Lewis, C. J. E., Macreadie, P. I., Glass, L., Gress, S., Jardine, S. L., Jones, T. G., ... Landis, E. (2018). A global map of mangrove forest soil carbon at 30 m spatial resolution. *Environmental Research Letters*, 13(5). <https://doi.org/10.1088/1748-9326/aabe1c>
- Samper-Villarreal, Jimena, Catherine E. Lovelock, Megan I. Saunders, Chris Roelfsema, Peter J. Mumby (2016) Organic carbon in seagrass sediments is influenced by seagrass canopy complexity, turbidity, wave height, and water depth. *Limnology and oceanography*. First published: 27 January 2016 <https://doi.org/10.1002/lno.10262>. <https://aslopubs.onlinelibrary.wiley.com/doi/full/10.1002/lno.10262>.
- Schuhmann, P. W. (2020). Valuation of ecosystem services as a basis for investment in Blue Economies. In *The Caribbean Blue Economy* (pp. 78-91). Routledge.
- Short, F. T., Short, C. A., & Novak, A. B. (2018). Seagrasses: Chapter 5. *The Wetland Book*, 73–91.
- Smith P., M. Bustamante, H. Ahammad, H. Clark, H. Dong, E.A. Elsiddig, H. Haberl, R. Harper, J. House, M. Jafari, O. Maser, C. Mbow, N.H. Ravindranath, C.W. Rice, C. Robledo Abad, A. Romanovskaya, F. Sperling, and F. Tubiello, 2014: Agriculture, Forestry and Other Land Use (AFOLU). In: *Climate Change 2014: Mitigation of Climate Change. Contribution of Working Group III to the Fifth Assessment Report of the Intergovernmental Panel on Climate Change* [Edenhofer, O., R. Pichs-Madruga, Y. Sokona, E. Farahani, S. Kadner, K. Seyboth, A. Adler, I. Baum, S. Brunner, P. Eickemeier, B. Kriemann, J. Savolainen, S. Schlömer, C. von Stechow, T. Zwickel and J.C. Minx (eds.)]. Cambridge University Press, Cambridge, United Kingdom and New York, NY, USA
- Shukla, P. R., Skeg, J., Buendia, E. C., Masson-Delmotte, V., Pörtner, H. O., Roberts, D. C., ... & Malley, J. (2019). *Climate Change and Land: an IPCC special report on climate change, desertification, land degradation, sustainable land management, food security, and greenhouse gas fluxes in terrestrial ecosystems*.
- Spalding, M. (2010). *World Atlas of Mangroves* (1st ed.). Routledge. <https://doi.org/10.4324/9781849776608>
- Tiner, R. W., & Milton, G. R. (2018). Estuarine marsh: An overview. *The Wetland Book II: Distribution, Description, and Conservation*, 1, 55–72. [https://doi.org/10.1007/978-94-007-4001-3\\_183](https://doi.org/10.1007/978-94-007-4001-3_183)
- Tobias, C., & Neubauer, S. (2009). Chapter 16 - Salt Marsh Biogeochemistry - An Overview. In *COASTAL WETLANDS: An Integrated Ecosystem Approach* (First edit, Vol. 76, Issue February 2016). Elsevier. <https://doi.org/10.1016/B978-0-444-53103-2.00016-8>
- Tuinhof, T. (2014) Modelling far-field dredge plume dispersion. Tu Delft. Master thesis. Rotterdam, October 2014.
- UNEP-WCMC, Short FT (2021). Global distribution of seagrasses (version 7.1). Seventh update to the data layer used in Green and Short (2003). Cambridge (UK): UN Environment World Conservation Monitoring Centre. Data DOI: <https://doi.org/10.34892/x6r3-d211>
- UN Environment (2018). *Assessing Environmental Impacts - A Global Review of Legislation*, Nairobi, Kenya.
- UNESCO (2020). *UNESCO Marine World Heritage: Custodians of the globe's blue carbon assets*. Paris, France
- Van Rijn (2015). Land reclamations of dredged mud. (accessed: Landreclamationmud2015.pdf at: [leovanrijn-sediment.com](http://leovanrijn-sediment.com)).
- Verra (2021, September 9). *First Blue Carbon Conservation Methodology Expected to Scale Up Finance for Coastal Restoration & Conservation Activities*. <https://verra.org/first-blue-carbon-conservation-methodology-expected-to-scale-up-finance-for-coastal-restoration-conservation-activities/>
- WBCSD/WRI (2011). *The Corporate Value Chain (Scope 3) Accounting & Reporting Standard*. [www.ghgprotocol.org/files/ghgp/Corporate%20Value%20Chain%20%28Scope%203%29%20Accounting%20and%20Reporting%20Standard.pdf](http://www.ghgprotocol.org/files/ghgp/Corporate%20Value%20Chain%20%28Scope%203%29%20Accounting%20and%20Reporting%20Standard.pdf)



**In collaboration with:**



**Deltares**

**Supported by:**



**Suggested reference:**

Nieuwkamer, R., Kox, M.A.R., Fiselier, J., van Wieringen, D.R.G., Tonneijck, F.H., Cronin, K., ten Bosch, W. 2022. Reducing the ecosystem-based carbon footprint of coastal engineering (Wetlands International).

**For more information please contact:**

Femke Tonneijck, PhD, Programme Head Wetland Carbon

[Femke.Tonneijck@wetlands.org](mailto:Femke.Tonneijck@wetlands.org)

**Read the full report:**

[www.wetlands.org/publications/reducing-the-ecosystem-based-carbon-footprint-of-coastal-engineering/](http://www.wetlands.org/publications/reducing-the-ecosystem-based-carbon-footprint-of-coastal-engineering/)

June 2022







# Reducing the ecosystem-based carbon footprint of coastal engineering

---

Technical publication